

June 2018

# MARITIME REPORTER AND ENGINEERING NEWS

MARINELINK.COM

# ZERO

The **All-Electric, zero-emission Future of The Fjords** has arrived

## Clean Oceans

Nippon Foundation Takes the Lead

## Hybrid Drives

Odin's Eye & The Quiet Trawler

## Cruising China

China Angles to Dominate Cruise  
Shipbuilding, Shipping Finance

## Green Marine Coatings

Fighting Nature with Nature

# We're **saving** much more than fuel.

BAE Systems' HybriGen® electric power and propulsion system saves fuel, reduces emissions, and increases engine life with its patented technology. HybriGen® variable speed gensets provide not only propulsion but also auxiliary power on demand for ferries and service vessels.

Ask us how we can help you become more efficient with BAE Systems' hybrid and electric marine solutions.

[hybridrive.com](http://hybridrive.com)



Red & White Fleet's **Enhydra**  
Hybrid Electric Passenger Vessel  
Built by All American Marine

**BAE SYSTEMS**

We didn't achieve sixty years of innovation all by ourselves.

Great innovation stems from teamwork. Decade after decade, our best ideas and most lasting solutions have come from working as team members with those most affected by the outcome. On our sixtieth birthday, we thank you – our clients, our colleagues, and our friends – for standing shoulder-to-shoulder with us through the years. It has been our greatest honor to support the important work you do, in an industry whose impact inspires us every day. So we will see you out there, on the water, in the shipyards, and on the tugs, tankers, barges, ferries, and other vessels that make our world go 'round.

**We can't wait to serve you for another sixty years.**



**Glosten**



**CELEBRATING 60 YEARS**

[GLOSTEN.COM](http://GLOSTEN.COM)

1201 WESTERN AVENUE, SUITE 200  
SEATTLE, WASHINGTON 98101-2953

# At the Helm

Nippon Foundation



## 18 Sasakawa

Nippon Foundation chairman Sasakawa fights for healthy oceans.

**By Greg Trauthwein**

## 28 The Quiet Trawler

France Pelagique benefits from 'Odin's Eye'

**By William Stoichevski**



Hayward Ship Technology



Brødrene Aa

## 32 Zero Emissions

The Future (of the Fjords) is now.

**By Tom Mulligan**

## 38 Dubai's Time

With more than 5,500 maritime companies, Dubai has arrived.

**By Mark Venables**



Credit: Dubai Maritime Cluster Office



SunStone Ships

## 42 China Rising

China earns cruise newbuild business, aims for ship finance.

**By Greg Trauthwein**



## MIND FOR MARINE

What better way is there to cut emissions and future-proof your vessel than to combine a Power Drive with permanent magnet drive train technology to create a diesel electric, hybrid or fully electric system?

As masters of DC-hub distribution and redundancy, we at Yaskawa Environmental Energy will help you switch to absolute endurance.

Ask us how.

[www.theswitch.com](http://www.theswitch.com)

# YASKAWA

## THE COVER

### Decarbonization of the Maritime Industry

As all roads lead to emission reduction and eventually decarbonization in the maritime world, the next step has been taken in Norway with the Future of the Fjords. Story starts on page 32.

© Brødrene Aa



# MARITIME REPORTER AND ENGINEERING NEWS

MARINELINK.COM

ISSN-0025-3448

USPS-016-750

No. 6 Vol. 80

Maritime Reporter/Engineering News (ISSN # 0025-3448) is published monthly (twelve issues) by Maritime Activity Reports, Inc., 118 East 25th St., New York, NY 10010-1062. Periodicals Postage Paid at New York, NY and additional mailing offices.

**POSTMASTER:** Send all UAA to CFS. NON-POSTAL AND MILITARY FACILITIES send address corrections to Maritime Reporter, 850 Montauk Hwy., #867, Bayport, NY 11705.

The publisher assumes no responsibility for any misprints or claims or actions taken by advertisers. The publisher reserves the right to refuse any advertising. Contents of the publication either in whole or part may not be produced without the express permission of the publisher. Copyright © 2018 Maritime Activity Reports, Inc.

### SUBSCRIPTION INFORMATION

**In U.S.:**  
One full year (12 issues) \$84.00;  
two years (24 issues) \$125.00

**Rest of the World:**  
One full year (12 issues) \$110.00;  
two years \$190.00 (24 issues)  
including postage and handling.

Email: [mrcirc@marinelink.com](mailto:mrcirc@marinelink.com)  
Web: [www.marinelink.com](http://www.marinelink.com)  
t: (212) 477-6700  
f: (212) 254-6271

## On Point



### When America Sneezes

## 14 THE WORLD GETS A COLD

*From double hull tankers to ballast water regulations to economic sanctions, U.S. actions continued to deeply impact the shape and direction of global maritime matters.*

By Joe Keefe

### Bryant



### Dobie



### Haun



### Keefe



### In this edition

Editorial	6
Trending	8
Government Update	10
Heavy Lifters	12
On Point with Keefe	14
Digitalization	16
People & Companies	48
Product: Firefighting	50

Marine	
Equipment Guide	56
Buyer's Guide	58
Classified	59
Advertiser's Index	64

### Mulligan



### Sanusi



### Stoichevski



### Venables



### Bryant

Dennis is with Maritime Regulatory Consulting, and a regular contributor to Maritime Reporter.

### Dobie

Bill is founder & CEO of SED-NA, a cloud-based communication and transaction management platform designed for the shipping sector to help reduce operating costs and improve efficiency.

### Haun

Eric is a NYC-based journalist, web editor of MarineLink.com

and a contributor to New Wave Media's portfolio of global energy reports.

### Keefe

Joe is the editor of Maritime Logistics Professional and MarineNews.

### Mulligan

Tom is Maritime Reporter's science and technology writer based in Ireland.

### Sanusi

Yahaya is Deputy Head of Transport Engineering at AAL, and

has worked in shipping for more than two decades. Prior to joining AAL, Yahaya worked at Thyssen Nordseewerke shipyard, Macor Neptune, and Beluga Shipping.

### Stoichevski

William is Maritime Reporter & Engineering News' editor in Norway.

### Venables

Mark is an experienced maritime journalist and editor that has covered the sector for over 20 years for both national press and maritime trade publications.

# THIS IS DARYL WILSON, CEO OF HYDROGENICS. AND HE'D LIKE TO INTRODUCE YOU TO OUR ADVANCED HYDROGEN TECHNOLOGY MANUFACTURING FACILITY.



Today Daryl is feeling inspired. After all, he's leading a shift to a cleaner, global energy future through hydrogen technology. With growing production facilities in Canada, the U.S., Belgium and Germany, we're designing and engineering innovative solutions for hydrogen generation, power storage and transportation. OEMs, cities, and other partners are looking to Hydrogenics for carbon-free solutions that reliably and

safely transform how we consume energy. While our leadership comes from our technology, our success is the result of one essential ingredient – the human one. Our experts, our engineers, our researchers and our day-to-day people are focused on advancing hydrogen technology for a better, earth-friendly energy source. Learn how the human factor is changing the world at [Hydrogenics.com](https://hydrogenics.com)

## HYDROGENICS

The **human** factor. The most advanced part of our technology.

# Free & Clear

On my 'bucket list,' which alarmingly is getting longer as time grows shorter, is taking a cruise along the scenic west coast of Norway, traversing its magnificent fjords. Personally I've been to Norway more than 30 times in my life, and while I have visited nearly every corner of the country, I've not yet made the time to take this journey.

So when the opportunity arose to do so, no less aboard the magnificent new Future of the Fjords, you can imagine my disappointment when the inevitable business trip schedule threw up a road block, and I had to decline.

My disappointment was tempered with the elation of our Ireland-based science and technology writer, Tom Mulligan, who immediately jumped at the chance. Tom has been a regular in our pages for several years, and he has a long and distinguished career delivering compelling text on technical topics.

Future of the Fjords is perhaps the most aptly named vessel in the world, as this all-electric, zero-emission vessel is but the tip of the iceberg as the collective commercial maritime market wrestles with ever stricter emission standards, with the aim of complete decarbonization.

The carbon-fiber sandwich and vinylester passenger catamaran was launched in April this year by Norwegian tours operator The Fjords, and is now operating as a cruise vessel on the spectacular Gudvangen to Flåm route along the Nærøyfjord, Sognefjord and Aurlandsfjord of western Norway. Constructed by specialist shipbuilder Brødrene Aa, the new vessel powers up courtesy of an innovative power dock, which in addition to powering the vessel takes on gray and black water to ensure no sewage discharge into the pristine waters between Gudvangen and Flåm.

### "Under the skin, this new craft is a different beast"

That is exactly how The Fjords CEO Rolf Sandvik described the amazing new vessel in his fleet's stable.

"We now hope Future of the Fjords can become a benchmark for environmentally responsible vessel operators worldwide, ushering in a new breed of clean, green and spectacular passenger transportation."

While Future of the Fjords is a notable step, the likelihood of complete decarbonization of the maritime sector, in my lifetime, is improbable if not impossible. Simply put, there are far too many technical hurdles ahead, and with maritime serving as the critical veins and arteries in the flow of global commerce, there is zero chance of a swift change that could and would completely upend the business case of shipping.

But the path to decarbonization is intriguing, and it is my best guess that there will be some fascinating technological advances in the coming decade, advances that



heretofore would have been deemed impossible.

I had a conversation recently with Yohei Sasakawa, Chairman, Nippon Foundation, that fit picture perfect into this discussion. Nippon Foundation is a philanthropic organization active globally with a simple mission, social innovation. When founded in 1962 its efforts focused largely on the maritime and shipping fields, but today it is more diverse. Regardless, all matters maritime remain at the heart of the organization, and Sasakawa and the organization he leads take a long view, I mean a really long view of thousands of years in the future, when discussing the sustainability of the world's oceans and their role in the preservation of human existence. I believe you will find his observations on the health of the world's waters and the topic of ocean governance of tremendous interest. The story starts on page 18.

**Gregory R. Trauthwein**  
Editor & Associate Publisher  
trauthwein@marinelink.com

## MARITIME REPORTER AND ENGINEERING NEWS

MARINELINK.COM

**HQ**  
118 E. 25th St., 2nd Floor  
New York, NY 10010 USA  
Tel +1 212 477 6700  
Fax +1 212 254 6271  
www.marinelink.com

**FL Office**  
215 NW 3rd St  
Boynton Beach, FL 33435-4009  
Tel +1 561 732 4368  
Fax +1 561 732 6984

**Publishers**  
John E. O'Malley  
John C. O'Malley  
jomalley@marinelink.com

**Associate Publisher/Editorial Director**  
Greg Trauthwein trauthwein@marinelink.com

**Vice President, Sales**  
Rob Howard howard@marinelink.com

**Web Editor**  
Eric Haun haun@marinelink.com

**Web Contributor**  
Michelle Howard mhoward@marinelink.com

**Editorial Contributors**  
Elaine Maslin - Scotland  
Tom Mulligan - UK  
Claudio Paschoa - Brazil  
Peter Pospiech - Germany  
William Stoichevski - Scandinavia

**Production**  
Irina Vasilets vasilets@marinelink.com  
Nicole Ventimiglia nicole@marinelink.com

**Corporate Staff**  
Mark O'Malley, Marketing Manager  
Esther Rothenberger, Accounting

**Information Technology**  
Vladimir Bibik  
Emin Yuce

**Subscription**  
Kathleen Hickey k.hickey@marinelink.com

**Sales**  
Lucia Annunziata annunziata@marinelink.com  
+1 212 477 6700 ext 6220

**Terry Breese**  
breese@marinelink.com  
+1 561 732 1185

**John Cagni**  
cagni@marinelink.com  
+1 631-472-2715

**Frank Covella**  
covella@marinelink.com  
+1 561 732 1659

**Mitch Engel**  
engel@marinelink.com  
+1 561 732 0312

**Mike Kozlowski**  
kozlowski@marinelink.com  
+1 561 733 2477

**Jean Vertucci**  
vertucci@marinelink.com  
+1 212 477 6700 ext 6210

**International Sales**  
**Scandinavia & Germany**  
Roland Persson roland@orn.nu  
Orn Marketing AB, Box 184, S-271 24  
Ystad, Sweden  
t: +46 411-184 00 f: +46 411 105 31

**United Kingdom**  
Paul Barrett ieaco@aol.com  
Hallmark House, 25 Downham Road, Ramsden  
Health, Essex CM11 1PU UK  
t: +44 1268 711560 m: +44 7778 357722  
f: +44 1268 711567

**Classified Sales +1 212 477 6700**

**Founder:**  
John J. O'Malley 1905 - 1980  
Charles P. O'Malley 1928 - 2000

Watch us



Download our Apps

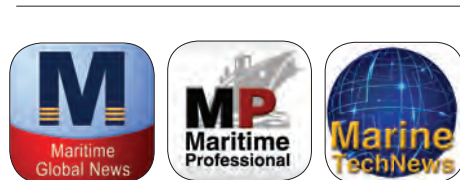

Follow us on Social Media



Check out our websites:







[smm-hamburg.com](http://smm-hamburg.com) [/trailer](#)

the leading international  
maritime trade fair

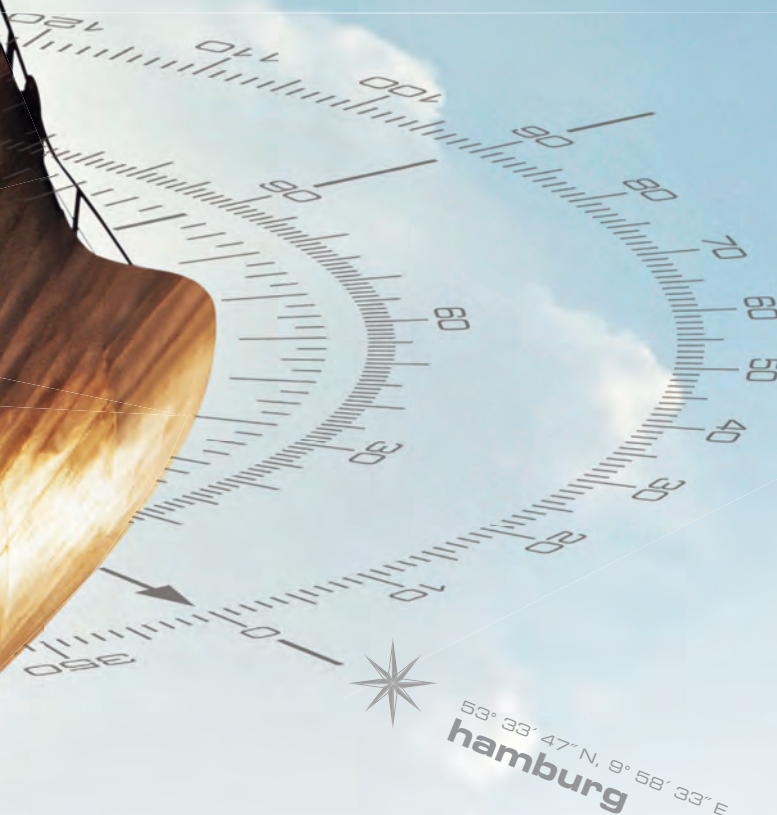

# setting a course

**4-7 sept 2018**

**hamburg**

3 sept	Maritime Future Summit
4 sept	TradeWinds Shipowners Forum
5 sept	gmec, global maritime environmental congress
6 sept	Offshore Dialogue
6-7 sept	MS&D, international conference on maritime security and defence
7 sept	Maritime Career Market



**Hamburg Messe**



[facebook.com/SMMfair](https://www.facebook.com/SMMfair)

[linkedin.com/company/smmfair](https://www.linkedin.com/company/smmfair)

[#SMMfair](https://twitter.com/SMMfair)

[youtube.com/SMMfair](https://www.youtube.com/SMMfair)

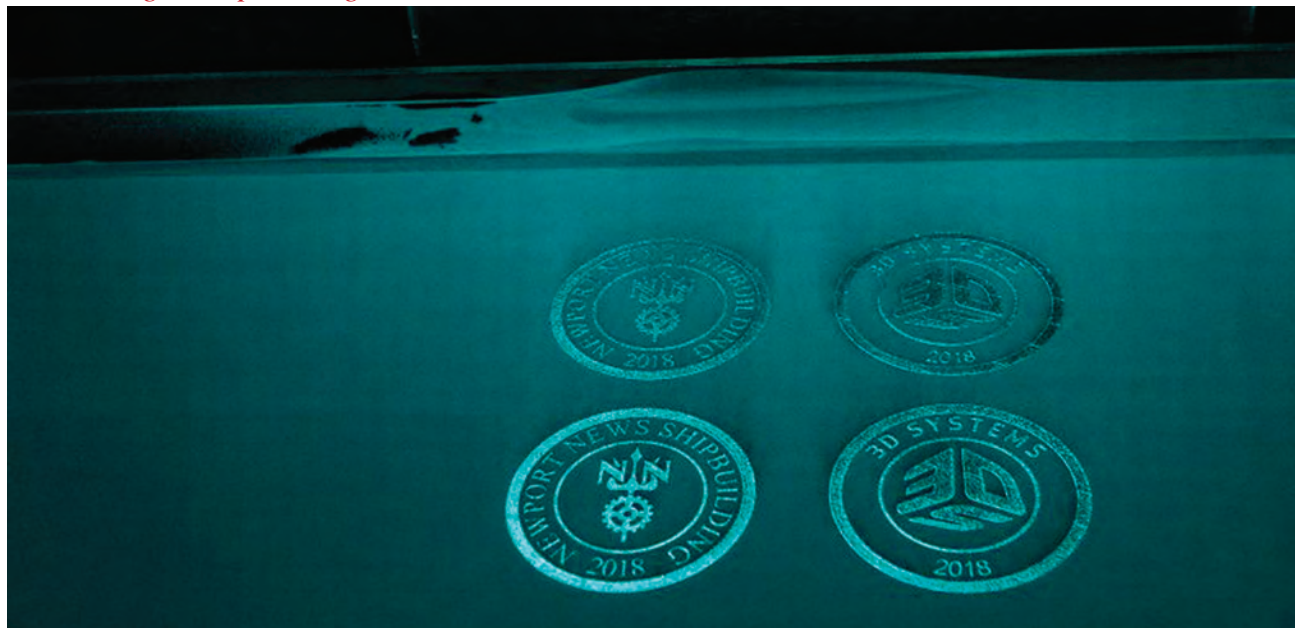

John Whalen/HII

## HII, 3DS Partner for 3D Printing

Huntington Ingalls' Newport News Shipbuilding division will work with 3D Systems to develop additive manufacturing technologies expected to accelerate the adoption of metal 3D printing for building components of U.S. warships.

The joint effort, which comes amid a significant technological transformation underway at Newport News, is expected to support future qualification and certification programs necessary to implement this advanced manufacturing technology for the U.S. Navy and further revolutionize how shipbuilders build the next generation of warships.

Through this collaboration, the

shipbuilder will move portions of its manufacturing process from traditional methods to additive, anticipating enhanced production rates of high accuracy parts with reduced waste, and potential for significant cost savings over other traditional production processes.

"This is a game-changing and disruptive technology for our industry," said Charles Southall, Newport News' vice president of engineering and design. "In addition to our ongoing digital shipbuilding efforts, 3-D printing could transform our design standards, and this technology has the potential to be one of the most significant manufacturing innovations in our industry since we

began building nuclear-powered ships in the 1950s."

As part of the joint development agreement, 3D Systems delivered and installed the ProX DMP 320 high-performance metal additive manufacturing system at Newport News. The state-of-the-art machine is capable of making three-dimensional, marine-based, alloy parts for castings or other fabricated parts, such as valves, housings and brackets.

**Pictured: Logos from Newport News Shipbuilding and 3D Systems were fabricated during a demonstration of the new 3-D printer.**

*The Largest  
Maritime Social  
Media Network in  
the World.*



**130,096**  
LinkedIn Group  
Members  
(industry's largest)



© Herbert Boettcher 2018

### *Photo of the Month*

#### **Clean Containership**

**View onto the cleaned container vessel before new cargo will be loaded.**

Herbert Boettcher took this photo for Hamburg Süd when he travelled on the container ship Cap San Antonio from Europe to South America and back to Hamburg. Boettcher started with his worldwide long time project Seamotion in 2004. Boettcher is a German professional photographer working worldwide for shipping companies to create photos of merchant ships with his unique visual language. He has been working as a graduate designer for more than 20 years and has already received numerous awards for his applied and free photographic work.

Visit his website:  
[www.HerbertBoettcher.com](http://www.HerbertBoettcher.com)

Contact him at:  
[info@HerbertBoettcher.com](mailto:info@HerbertBoettcher.com)

Rolls-Royce



## Rolls-Royce Gas Turbines for Japan's New Frigate

Rolls-Royce said it was selected to supply its MT30 gas turbine to power a new class of frigates for the Japan Maritime Self Defence Force (JMSDF). Construction of the first of the 30FFM class frigates will begin next year, with entry into service expected around 2022.

Other recent military references for the MT30 include the U.K. Royal Navy's new aircraft carrier HMS Queen Elizabeth; the U.S. Navy's Freedom Class variant of the Littoral Combat Ship; the new DDG-1000 destroyers; the Republic of Korea Navy's first FFXII frigate; and Italy's new Landing Helicopter Dock program.

## Yacht Design: Meet the Sleek MY Roswell 65

Triptic Studio



The all-aluminum 65m superyacht MY Roswell is a futuristic design that is sure to make an impression wherever it may roam, a new design from the hands of George Lucian. The MY Roswell is as stunning technically inside as it is outside, designed to have full electric running capabilities, supported by two diesel electric engines and large electric panels that cover the numerous horizontal surfaces of the superstructure of the vessel.

At first glance it appears to be a military stealth craft, and together with the full electric capabilities, reflective hull surface, patterns, and sharp angles, make the yacht have a very discrete radar footprint, if any. While its radar footprint will be minimal, it is fairly assured that its presence in harbor will be anything but discrete.

## Silent Drive on Eco Vessel

Incat Crowther announced the launch of Spirit of the Wild, a new tour vessel for Gordon River Cruises, the first in Australia to operate in World Heritage-listed wilderness with Silent Drive. Built by Richardson Devine Marine, Spirit of

the Wild is fitted with a pair of MTU 10V2000M72 main engines. Added to this is a cutting-edge hybrid electric system, consisting of a pair of ABB e-motors, driving Hybrid-ready ZF gearboxes. Particular attention was given to the mounting of the engines and gears to reduce the transmission of vibration and noise. The main engines' modest rating is tailored to the local manning require-

ments. In open water, the vessel will use Boost mode from the hybrid system, which matches motor speed to engine speed to seamlessly add electric power. In this mode, the vessel operates at 25 knots. When the tour comes to the World Heritage-listed Gordon River, Silent Drive mode is engaged. In this mode, the main engines are shut down and the vessel runs on electric power.



Incat Crowther

# GET ON BOARD

## WITH OPEN SEAWATER LUBRICATED PROPELLER SHAFTS

**PROVEN PERFORMANCE:**

**550+ commercial ships are using**

**Thordon COMPAC bearings**

**SUBSTANTIALLY LOWER**

**OPERATIONAL COST.**

**Compared to a sealed oil system**

**FUTURE COMPLIANT:**

**Meets VGP & Polar Code Regulations**

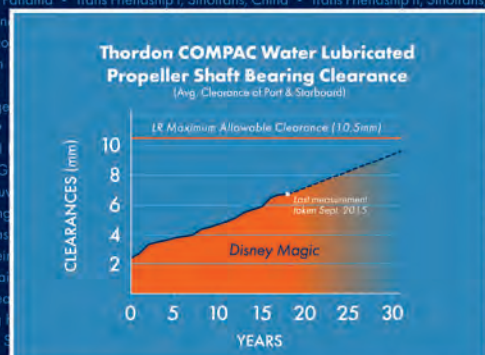

To learn more visit us online at [thordonbearings.com/provenperformance](http://thordonbearings.com/provenperformance)

## Specify an Open Thordon COMPAC Seawater Lubricated Propeller Shaft Bearing System for your newbuild.

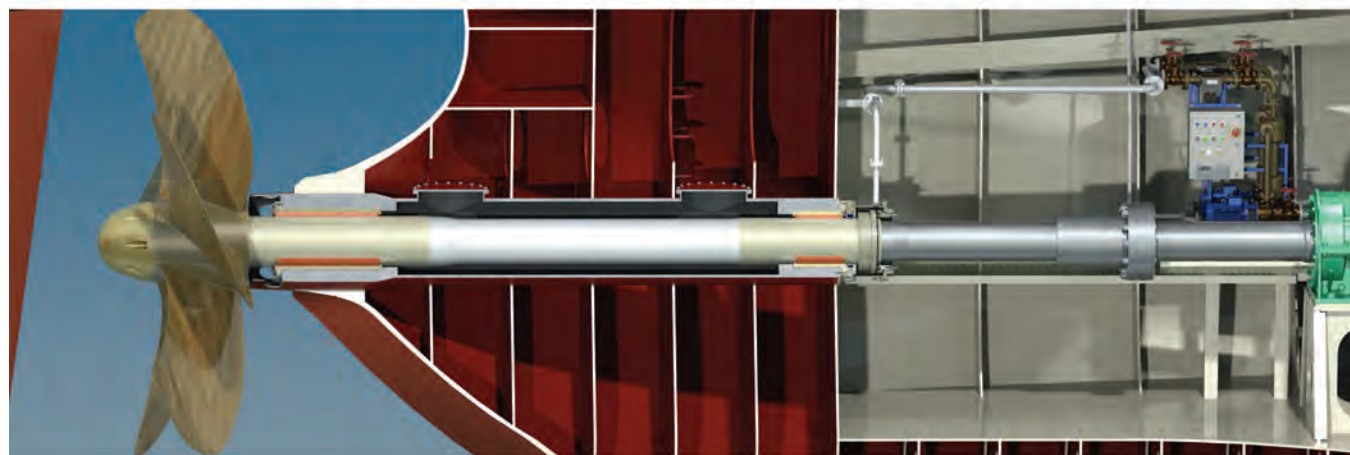

# THORDON

THORDON BEARINGS INC.

ZERO POLLUTION | HIGH PERFORMANCE | BEARING & SEAL SYSTEMS  
For more information contact Thordon or your local authorized Thordon distributor at [www.ThordonBearings.com](http://www.ThordonBearings.com)

# Rerouting a River

The Old River Control Structure and its future implications for river-borne commerce



## About the Author

Dennis L. Bryant is with Bryant's Maritime Consulting, and a regular contributor to Maritime Reporter & Engineering News as well as online at MaritimeProfessional.com.   
 t: 1 352 692 5493  
 e: dennis.l.bryant@gmail.com

Prior to about 1500, the bodies of water now called the Mississippi River and the Red River (also known as the Red River of the South) were roughly parallel along their southern reaches, each emptying separately into the Gulf of Mexico. About 1500, the Mississippi, which has a long history of meandering, developed

a large bend to the west in the vicinity of what is now Point Breeze, Louisiana. That bend, sometimes referred to as Turnbull's Bend, connected with the Red River and had the effect of making the Red River basically a tributary of the Mississippi, with only a small portion of its waterflow continuing south. That

southern waterflow is now called the Atchafalaya River.

Everything was fine until 1831, because the water basins in that region shifted regularly about every 1,000 years. The land and its occupants, including humans, adjusted. The early 1800s saw the rise of the steamboat era.

Time became paramount. Turnbull's Bend was a 20-mile detour that only moved the steamboat two miles further as the crow flies. This was unacceptable.

Henry Shreve, a steamboat captain and owner, inventor, and engineer, had developed technology to clear snags and obstructions from the river. In 1831,

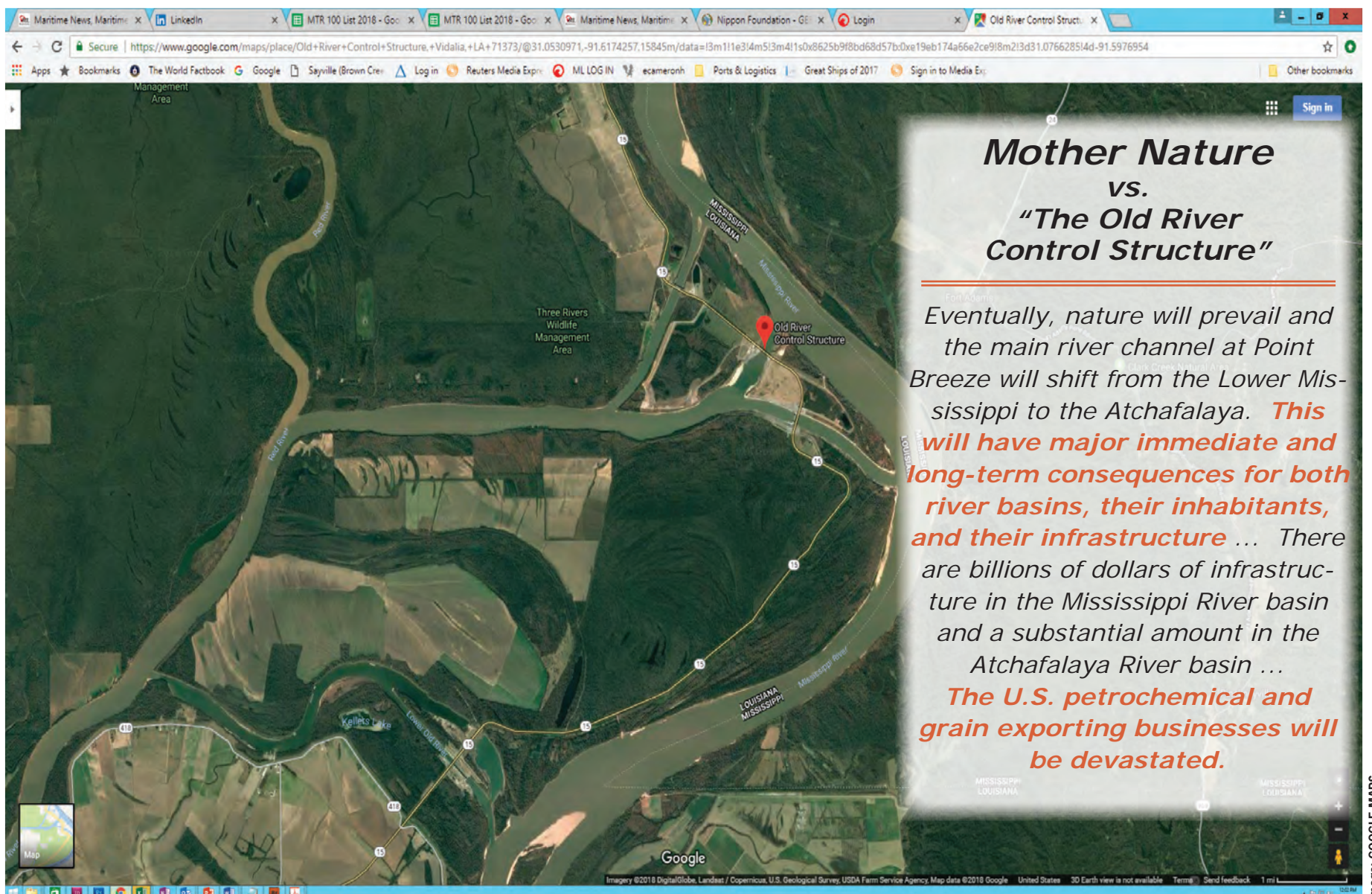

Image: GOOGLE MAPS

he dug a shortcut across the narrowest portion of Turnbull's Bend, shortening the Mississippi by over 17 miles. The meander lost most of its waterflow and became known as the Old River and carried a relatively small amount of water between the Mississippi and the Red/Atchafalaya River.

When the Mississippi was high, the Old River flowed west. When the Mississippi was low, the Old River flowed east. The majority of the time, the Mississippi was higher than the Red/Atchafalaya River.

Initially, the total waterflow through the Atchafalaya was about 10% of that through the Mississippi, but over time this varied to as high as 30%. Since the length of the Atchafalaya was noticeably less than the length of the Mississippi from Point Breese to the Gulf and since the Mississippi continued to meander, there was concern that the Mississippi might eventually change course and flow through the Atchafalaya. This would have the effect of largely cutting Baton Rouge and New Orleans off from the significant waterflow, devastating their economies.

The U.S. Army Corps of Engineers (USACE) was called upon to resolve the potential problem. In 1963, it completed

construction of the Old River Control Structure at Point Breeze. The structure's mission was to maintain the status quo, keeping the waterflow of the Atchafalaya at 30% that of the Mississippi. This was accomplished by means of the Low Sill Control Structure for regulation of routine waterflow through operation of a dam and outflow channel and the Overbank Control Structure for supplemental waterflow control when the Mississippi floods. A navigation channel and lock were also included, allowing tugs and barges to transit between two river systems.

A major flood in 1973 severely tested the Control Structure and nearly caused its complete failure. Flood waters scoured a 55-foot hole under the south end of the Low Sill Control Structure and part of it collapsed into the waterway.

It took the emergency dumping of 250 thousand tons of rock into the waterway to save the structure.

An Auxiliary Structure was added in 1986 to reduce pressure on the original floodgates and a hydroelectric facility was added in 1990. The hydroelectric facility takes advantage of the difference in water levels between the two rivers to generate electricity and has largely elim-

inated the need for water to flow through the Low Sill Control Structure during normal conditions.

The problem with the hydroelectric facility is that it only removes water from the Mississippi. The silt is filtered and largely prevented from entering the Atchafalaya. As a result, the ever-present silt remains in the Big Muddy and is distributed through a smaller volume of water, while a noticeable amount of the clean water has been sent to the Atchafalaya River. The additional clear water leads to increased scouring of the Atchafalaya River basin.

The now siltier Mississippi has a difficult time keeping all that silt in suspension. Much of it descends to the bottom. As the river bottom comes up, so must the water level at the surface. This has the effect of requiring levees along the river to be raised. It also has the effect of increasing the pressure on the Old River Control Structure. The increased silt deposit is also a reason that dredging of the river in constantly taking place.

Eventually, nature will prevail and the main river channel at Point Breeze will shift from the Lower Mississippi to the Atchafalaya. This will have major immediate and long-term consequences for both river basins, their inhabitants,

and their infrastructure. Millions live within the Mississippi River basin south of Point Breeze. Another million live in the Atchafalaya River basin. There are billions of dollars of infrastructure in the Mississippi River basin and a substantial amount in the Atchafalaya River basin. In addition, those living and working in the Mississippi River basin depend on the river with its significant water flow to prevent salt water intrusion into the water table. The U.S. petrochemical and grain exporting businesses will be devastated.

The U.S. Army Corps of Engineers declines to say when this change in the water flow will occur, but does not argue with the proposition that it is inevitable. The Corps does say that it will continue to operate the Old River Control Structure, holding back the Mississippi's predilection to move west, so long as Congress continues to appropriate the necessary funds to maintain and upgrade the structure. There will come a point, though, when Plan B must be considered.

The Mississippi River and its Old River Control Structure are vital parts of our national infrastructure. Close attention to their situation is of national importance.

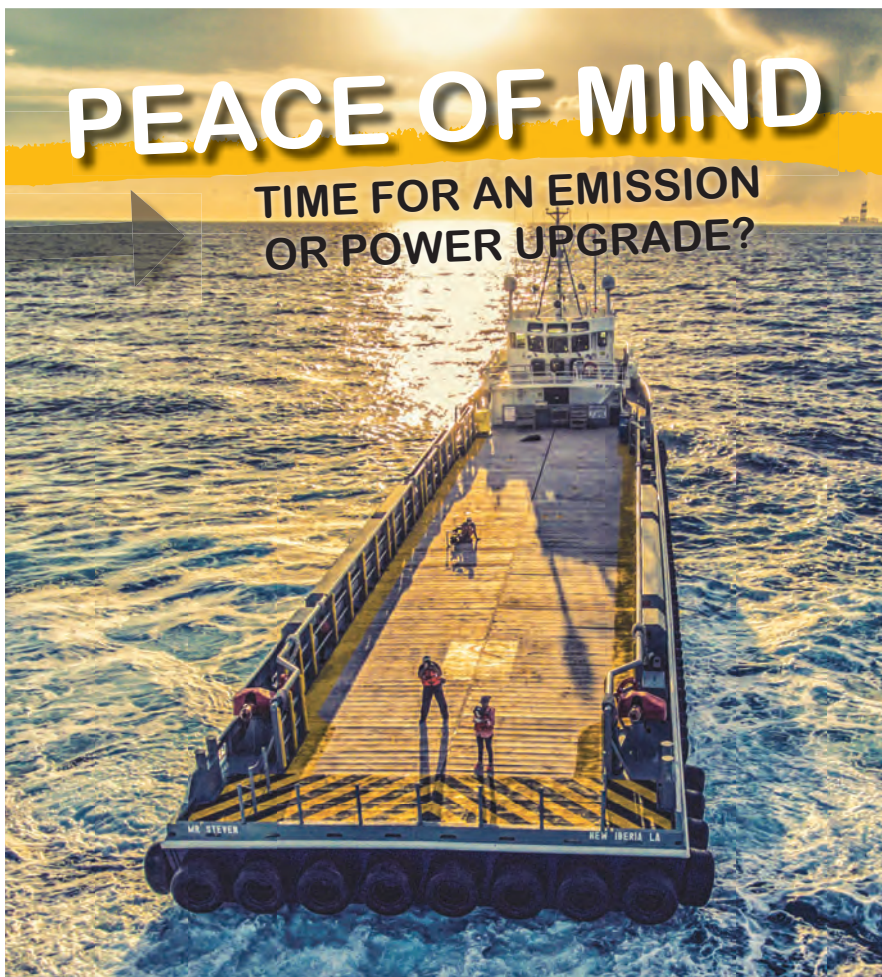

Louisiana Cat understands how important uptime is for your business, your crew and your bottom line. Now you can have peace of mind with the industry's best financing rates on Marine Engine Repower Packages.

**Request your quote online!**  
**Offer expires December 31, 2018.**

[www.LouisianaCat.com/Marine](http://www.LouisianaCat.com/Marine)

**BUILT FOR IT.**

**866-843-7440**



# Heavy Lifters

## *More than Machinery and Software, don't discount the Human Factor*

Engineering in shipping is a relatively simple science: computable and generally predictable. However, heavy lift shipping presents challenges that go far beyond what is required with standard unitized cargoes. The transportation of project cargoes – often highly valuable components of multi-billion-dollar projects – requires expert planning to ensure they are moved safely and efficiently.

For example, last year AAL shipped two giant cyclone vessels (22m x 11m x 10m and weighing over 500mt each) to Petronas' \$27 billion RAPID project in Malaysia. Cargoes of this size are never simple to transport. A huge amount of planning is required to calculate the optimal solution for loading and storage. The two cyclone vessels were loaded onto the AAL Fremantle, one of our 19,000dwt S-Class vessels, in Mailiao, Taiwan, using its combined 700mt cranes to safely lift and stow the cargo into one of its three giant, box shaped holds and weather deck respectively. Two weeks later they were safely delivered.

### **The Human Element**

As a specialist multipurpose carrier, first class engineering skills are fundamental to AAL's reputation as an expert in moving project cargo for such industries as mining, agriculture, oil and gas, energy and construction. We believe the most important factor in the safe loading of complex cargoes is not the specification of our equipment – important though this is – but the human element.

Lifting equipment is broadly similar across the heavy lift industry, at least among specialist carriers. Any high-quality carrier should invest in top-grade engineering equipment when lifting, loading, securing, transporting and un-

loading the extraordinary cargoes seen in the multipurpose sector, but it is the human element that separates one cargo carrier from the next, especially when a few centimeters can make all the difference.

AAL operate one of the youngest and most advanced fleets in the sector; 21 multipurpose vessels that offer superior infrastructure with side-mounted heavy lift cranes, large and even deck space, removable and height-adjustable 'tween decks, large box shaped cargo holds with independent dehumidifiers, strengthened tank tops as well as appropriate lifting and lashing equipment. With our mix of 31,000dwt A-Class, 19,000dwt S-Class and 33,000dwt W-Class vessels, we also lead the 'Mega MPP' vessel segment (30,000+dwt).

However, the key to the company is the expertise that we can deploy from our in-house technical and engineering team. This team has more than 50 years collective experience and a track record of being entrusted with some of the largest, heaviest and complex cargoes ever transported by sea. The role of our engineering team is to plan and execute complex cargo handling and securing solutions that ensure the safe transit of cargo, vessel and crew from port to port. It comprises the expertise of engineers, seafarers and naval architects to cultivate a detailed understanding of each cargo and its unique requirements.

### **New Software Tools**

We are also looking at new software technologies in cargo planning, to both improve safety and enable us to load more cargo on a single sailing. The areas where new technologies and methodologies will be intensified in the near future

include the structural strength of deck structures, motion response of vessels and the stability of vessels during lifting operations.

Transporting extremely heavy cargo puts a huge strain on our vessel decks. As the unit weight of cargo grows, we must ensure that the integrity of the deck structure is guaranteed at all times. The practice of using the 'uniform deck load' to calculate deck strength is insufficient and we need to intensify the application of better tools such as 'Finite Element Analysis'.

The issue of 'motion response' is rather trivial when a ship is docked at the pier, but much more serious on turbulent seas. Current practice is to use a traditional statistical approach to calculate motion, but we know that waves can be higher in winter than summer, or that wave energy differs from one area to another. We need to apply a more complex approach, such as motion response analysis, and installing motion sensors on board our vessels.

When it comes to vessel stability during lifting operations, the adoption of Resolution MSC.415(97) by the IMO Maritime Safety Committee is an important milestone in heavy lift shipping. When it takes effect in January 2020, for the first time there will be international legislation setting stability criteria for lifting procedures, instead of self-regulation. We are now collaborating with industry colleagues to develop the new software tools required to judge the lifting stability of an operation, in line with this rule.

### **Project Cargo Expertise**

The ability to deliver improvements in efficiency is particularly important in a tough market. Competition has in-



### **About the Author**

Yahaya Sanusi is Deputy Head of Transport Engineering at AAL, and has worked in shipping for more than 20 years. Prior to joining AAL, he worked at Thyssen Nordseewerke shipyard, Macor Neptune, and Beluga Shipping.

tensified with non-specialist operators, including bulkers, container lines and RoRos, making forays into the heavy lift market. This is a concerning trend that affects quality, as well as potentially impacting safety. Heavy lift shipping requires specialist solutions. In the energy sector for instance, it takes years of expertise to plan and execute the safe delivery of cargoes for today's power generation projects.

Project cargo is considerably more complex than standard breakbulk, and there is a real risk that some operators will not ask the right questions or may overlook small but crucial details; details that would be second nature to a project cargo specialist.

We have undertaken complex projects that have been judged as logistically implausible by other carriers, and yet we delivered these cargoes safely, on schedule and within budget. High quality lifting equipment is essential, but to optimize this technical capability also requires careful planning and precise execution.

An experienced team of project cargo and operations specialists also play a crucial role in working in partnership with the customer. In a fast-moving industry where people regularly move on, knowledge and experience is at a premium. Although the immediate responsibility may lie with the freight forwarder, the global energy giants behind some of the world's biggest power generation projects still want to know that their cargo is in safe hands.

### **Emerging Technologies**

Exciting technological developments lie ahead. Just like autonomous cars are now being tested on our roads, the first

**Discharging giant  
RTG cranes from  
AAL Brisbane**

autonomous ship will be tested in 2019. Today we are limited when transporting tall cargo in case visibility from the command bridge is impaired. As long as safety standards are met, the authorities must accept new technologies such as proximity sensors and infra-red cameras to replace the naked eye.

There are other interesting technologies, such as Big Data Analytics, Expert Systems or Artificial Intelligence. All have hardly touched our industry yet, but I am sure they will find applications in the future, along with 3-D simulation and intelligent stowage planning.

The engineering tools and methodologies used in shipping have remained relatively similar for the last 15 years. If shipping is to keep step with technology, then we need to evolve, including our physical tools. However, while the equipment used is important, investment in the right people is still the key to maximising the value of a carrier's engineering capabilities.



Image: AAL

**Parker** Engineering your success

**Sea Recovery**

**TASMAN Sea T- 2**

Reliable service,  
new modern controls



**System Features:**

- Small footprint, large volume production, from 6,720 to 23,775 gallons per day
- Radial axial pump - doesn't require oil changes
- Available with Basic, Semi-Automatic, or Automatic controller options
- Industrial PLC control
- User-friendly color touchscreen
- Optional Ethernet/MODBUS communication



**AER SUPPLY LTD.**  
2301 NASA PARKWAY SEABROOK,  
TX 77586 USA  
**800 767 7606**  
SALES@AERSUPPLY.COM  
**AERSUPPLY.COM**

**f** facebook.com/AERsupplyLtd

**@AERsupplyLtd**

For more information:  
<http://bit.ly/aerproducts>

**SeaRecovery** manufactures various series of 'off the shelf' water makers ranging in capacity from 3230GPD (12000 LPD) up to 317006 GPD (1,200,000 LPD). Larger units can be custom build on request.

# When America *Sneezes* ...

## The rest of the world catches a cold!

It's been a long time since I served as a ship expeditor and cargo surveyor, immediately following my career at sea. In those days, the vast majority of cargo superintendents serving on the U.S. Gulf Coast, especially in the petroleum trades, were ex-mariners from abroad. The greatest number of those emanated from the UK, where in the late 1980s, apparently, the enticement of a \$36,000 annual salary and a dented, used company vehicle with 100,000+ miles on the odometer was enough to get them to sign up for a work visa and fly to the United States.

I was one of the few Americans actually doing that job at the time in the Gulf, so I got to know quite a few of them. On Friday afternoons, in the late 1980s and early 1990s, they typically got together in one of two British pubs in the greater Houston area, nostalgically tossed down a few pints of warm beer, ate their 'bangers and mash' and had a few laughs. As the token Yankee, I went as often as I could. After all, and if you didn't, they would talk about whoever wasn't there on that particular day. Or, in other words, as they say inside the Beltway, "If you aren't at the table, you're

probably on the menu."

It was all good fun. I miss it, actually – both the cargo work and the beers at the pub. On one occasion, we were talking about the local Houston economy in general – which wasn't all that great at the time – and one of my British friends gravely said to me, "When America sneezes, the rest of the world catches a cold." And, regardless of where you stand in the political spectrum, where you hail from, or who you support, it is quite clear (at least to me) that he was right – both then and now.



### About the Author

Joseph Keefe is a 1980 (Deck) graduate of the Massachusetts Maritime Academy and the editor of both Maritime Logistics Professional and Marine-News magazines. He can be reached at [keefe@marinelink.com](mailto:keefe@marinelink.com)

### America Sneezes

I've never forgotten that little bit of wisdom. That said; the current situation surrounding the recent U.S. decision to abandon the 2015 nuclear accord with Iran immediately comes to mind. Reuters is reporting that Shipping group A.P. Moller-Maersk was the latest in a growing roster of firms preparing to exit Iran. That leaves many stakeholders to wonder whether the EU can keep the nuclear deal with Tehran both alive and relevant. In that regard, it hasn't been a good start to the week.

Maersk's decision follows similar moves by other such heavyweights as French oil major Total and MSC, the world's second biggest container shipping company. The reasoning is obvious. There's probably a lot more business to be lost on this side of the big pond than there might be in Iran. And, politics aside, who would you rather deal with on a daily basis? Nevertheless, the current sanctions mess is only one such example of this metric in play.

Reuters reported that Maersk Chief Executive Soren Skou said, "With the sanctions the Americans are to impose, you can't do business in Iran if you also have business in the U.S., and we have that on a large scale."

Indeed, this is now as much about business as it is about politics – or global security. After all, much of the global supply chain is holding its breath to see what happens next.

### Catching a Cold

As an example, I have been covering invasive species and the ballast water treatment story thread for more than fif-

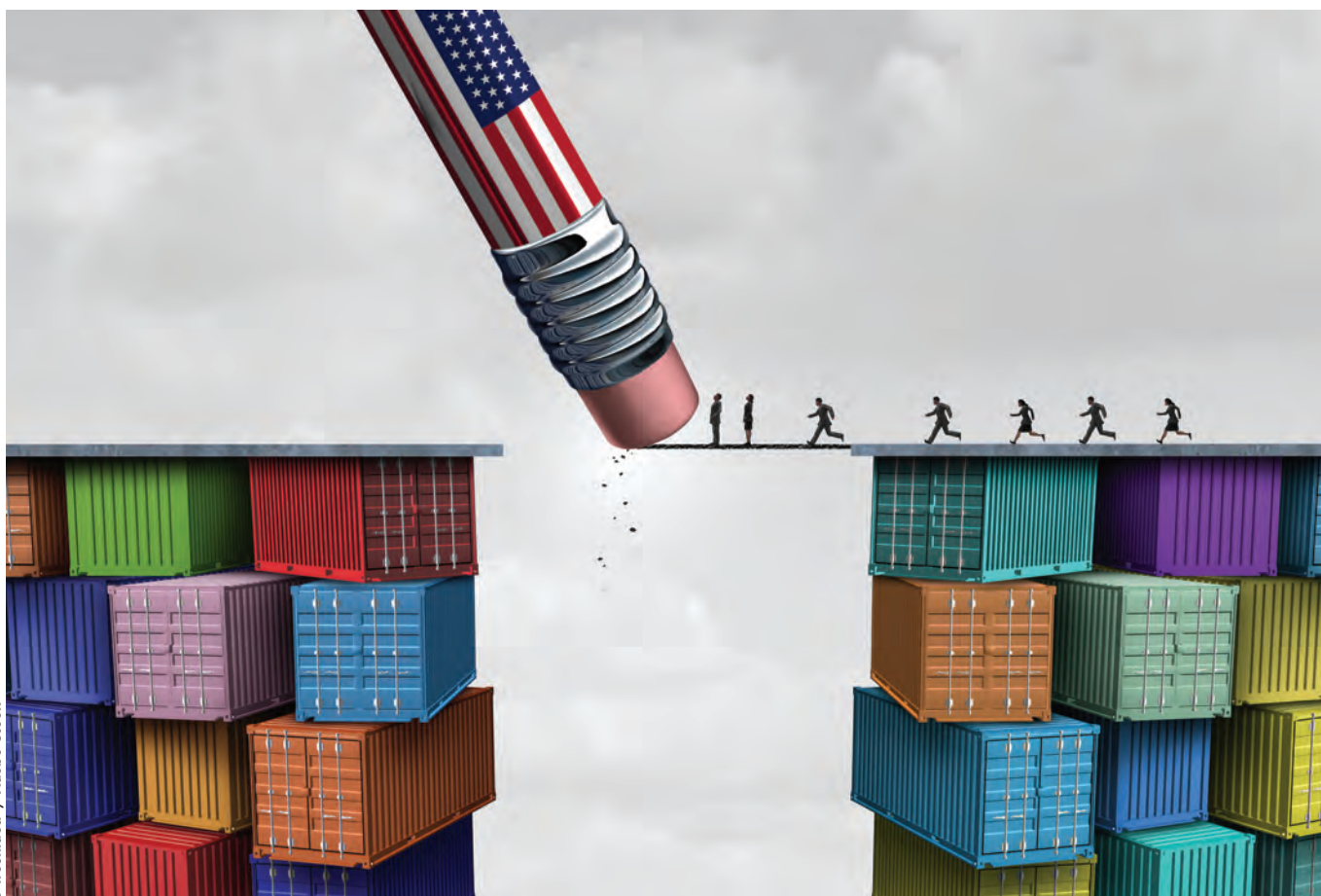



teen years. Always entertaining, never easy to understand, it has, over time, been the ‘gift’ story that keeps on giving. Some shippers, upon hearing the news of the IMO decision to delay implementation of the ballast water convention for some ships, breathed a heavy sigh of relief. Many still think that they can kick the can down the road a bit longer. For those who want to trade in U.S. waters, however, that’s not necessarily true.

In U.S. waters, there’s no such delay planned. BWTS systems are being approved and there are more than a few in the pipeline, the approval process, testing and those who have submitted their paperwork to the Coast Guard for approval. To that end, the Coast Guard’s escalating enforcement of ballast water discharge violations has resulted in a civil penalty proceeding against a bulk carrier for discharging ballast water in Washington State without using a U.S. Coast Guard Type Approved Ballast Water Management System (BWMS) or other approved means. In that case,

the Coast Guard proposed the maximum penalty of \$38,175. Separately, another vessel was fined \$5,000 for a similar unauthorized discharge in Oregon.

Given the regulatory and political history of the ballast water saga over these past 15 years, it’s sometimes hard to recognize the United States as a leader in the quest to eradicate invasive species. After all, it wasn’t too long ago that California was insisting upon an efficacy standard of 1,000x the IMO’s benchmark (matching approximately what the Coast Guard asks for today), despite the fact that the technology to achieve that standard doesn’t yet exist. Nor, can it be measured to that standard with currently existing equipment.

And, who could forget when the state of New York ‘blinked’ when Canada threatened to disrupt SEAWAY Shipping if the Empire State didn’t smarten up and come up with a san(er) ballast water strategy?

Beyond that, as many as 17 different individual State mandated standards cre-

ated a Balkanized enforcement nightmare that most stakeholders had trouble keeping up with, even with a scorecard at the ready. The so-called federal VIDA legislation being pushed for by AWO, LCA and others got caught in the mid-term madness last week and is today no closer to passage. VIDA – the Vessel Incidental Discharge Act – seeks to both standardize the regulations and bring enforcement under one umbrella. It’s a good idea whose time has come.

Nevertheless, and even with all that domestic uncertainty abounding, the United States, especially in the wake of the latest MEPC timelines, has quietly crept into a leadership role.

Separately, our younger readers might not remember that it was the Oil Pollution Act of 1990 (OPA 90), following the tragic Exxon Valdez grounding, which ultimately changed how we protect the marine environment, ensures that offending parties are held accountable and that all operators operate in a standardized, environmentally correct fashion.

The international community, when OPA 90 was rolled out, said in effect, “Oh, no, you can’t.” But, the U.S. government did it anyways. Hence, if you wanted to trade in U.S. waters, you got on board. And, here we are today. The world is better for it. Sure: it doesn’t always turn out that way.

#### On the Waterfront: Will History Repeat Itself?

It really isn’t an apples-to-apples comparison, is it? Or, maybe it is. A long time ago, the world’s largest trading partner said that shippers would have to comply with OPA-90 in U.S. waters. That same nation now says that you need to be in compliance when it comes to ballast water treatment in U.S. waters. The latest news on the Iran nuclear deal might just follow a similar pattern. If so, then what comes next shouldn’t surprise anyone. That’s because, “when America sneezes, the rest of the world catches a cold.”

– MLPro

# MSSH Is Your Single Global Source

Diesel Engines • Turbochargers • Filtration • Automation/Electrical Engineering • On-Site Machining



MSSH packages what you need to maintain your assets. Call 800-622-6747



**MSSH** Motor-Services Hugo Stamp, Inc.  
Authorized Distributor and Service Center

www.mshs.com info@mshs.com +1 954-763-3660 800-622-6747



# Time

## Shipping's Most Valuable Commodity

The shipping industry – not for the first time and certainly not for the last – is having to learn new words and phrases that, we are reliably informed, mean something that will hugely impact the sector; even if no one yet seems sure how.

When it comes to interpreting these phrases, particularly those of a technological leaning, commonly held assumptions don't apply. 'Disruption', for example, is not at all related to port delays, strikes, or any other limitation to the smooth running of the global supply chain, but is in fact a force for good when it comes to challenging received wisdom and shattering the status quo.

Similarly, 'the blockchain' is, contrary to first impressions, a means of unblocking; while it's not a chain at all, and certainly not a paper one.

Interest in these new phrases peaked with news in January that global technology giant IBM and world-leading shipping company Maersk had entered a joint venture. The announcement heralded an era of "paperless trade" to help "reduce the time and cost for clearance and cargo movement", with blockchain-based smart contracts ensuring that all required approvals are in place, helping to speed up approvals and reduce mistakes. Tellingly, in their announcement IBM and Maersk cited the fact that the "cost of the

required trade documentation to process and administer many of these goods is estimated to reach one-fifth of the actual physical transportation costs". Given the context – that more than \$4 trillion in goods are shipped each year, and more than 80 percent of the goods consumers use daily are carried by the ocean shipping industry – the potential savings are almost beyond comprehension.

### Trade documentation...is estimated to reach one-fifth physical transportation costs

As an article in the New York Times in March 2017, entitled 'Blockchain: A Better Way to Track Pork Chops, Bonds,



### About the Author

Bill Dobie is Founder & CEO of SEDNA, a cloud-based communication and transaction management platform purpose-designed for the shipping sector to help reduce operating costs and improve team efficiency.

Bad Peanut Butter?' put it: "while [the] containers themselves can be loaded on a ship in a matter of minutes, a container can be held up in port for days because a piece of paper goes missing, while the goods inside spoil. The cost of moving and keeping track of all this paperwork often equals the cost of physically moving the container around the world."

IBM and Maersk have given us a glimpse at a world offering "paperless trade" to help reduce the time and cost for clearance and cargo movement. Crucially, the blockchain mitigates human error, and saves time – shipping's greatest commodity.

The concept of 'time as a commodity' is not a new one for shipping and its related industries that are constantly under pressure to deliver on time. In recent years, shipping has increasingly focused on the opportunity for digitalization to save time and reduce costs through improved efficiencies across the board, but with most attention focused on the vessel itself. Whether utilizing onboard data to optimize routes, reduce turnaround time in port, or cut supply chain costs through rationalization, efficiency is the lynchpin. Yet, this is a somewhat blinkered view, with much attention given to unlocking latent efficiencies to trade on the sea, but with land-based optimization overlooked; specifically, in the offices of cargo owners or shippers, ship owners, brokers and other key stakeholders controlling the supply chain.

Time-consuming processes related to internal and external communication around transactions, for example, have largely been ignored. Surprising perhaps when transaction inefficiency can blight a shipping business's ability to optimize employee time, adding up to 30% in

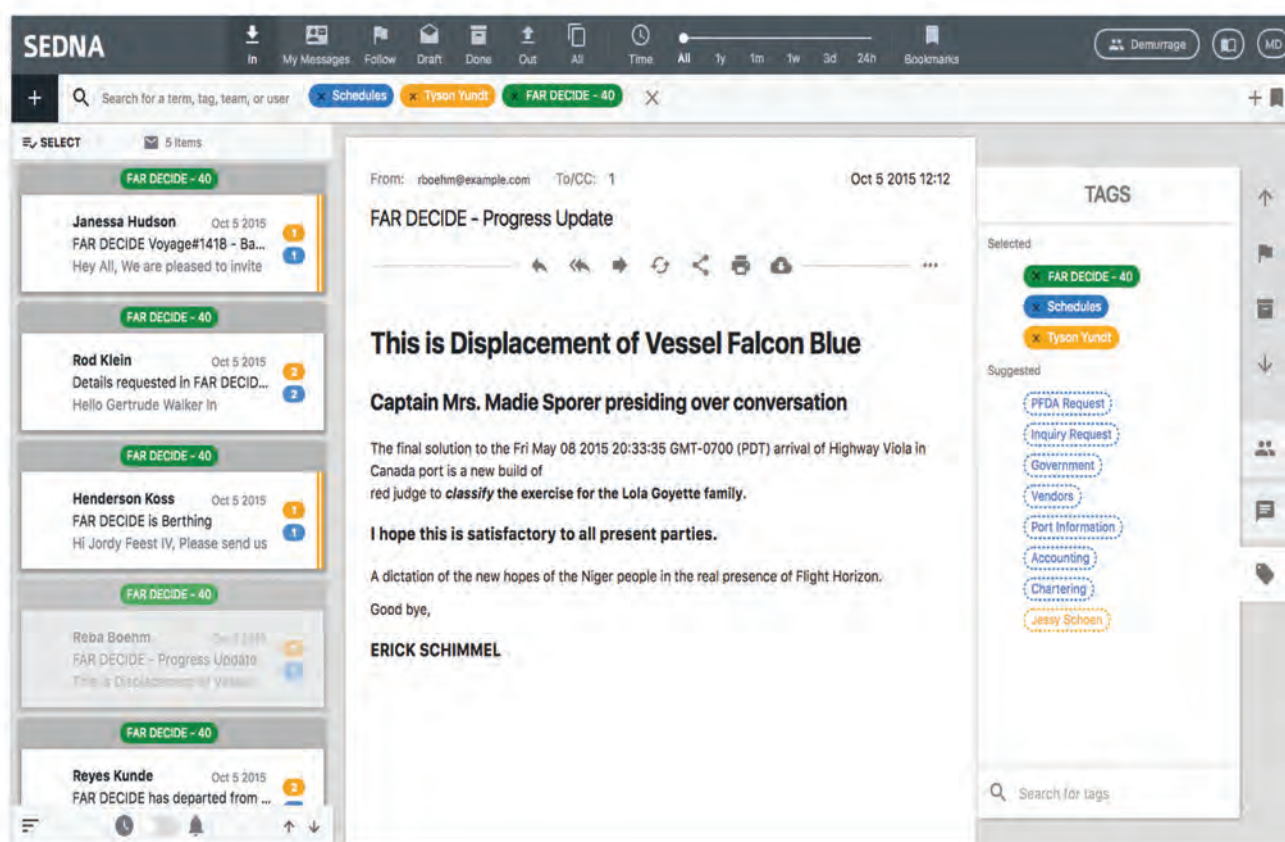

Image: SEDNA

SEDNA Systems Pte. Ltd. 2018

obsolete labor time, and consequently wasting millions of dollars.

### Time-consuming communication

One area of ‘transaction management’ that has been greatly overlooked is email – by far the most commonly used means of communication in the shipping industry. Email consumes our working lives, yet we rarely question the fact that we’ve been using it in the same way for years. Despite its ubiquity as a tool that almost all of us use, rely on and rarely question, it has become an antiquated, inefficient tool for business. This is perhaps less of a surprise when you consider that it was established fundamentally for personal communication and was never intended for collaboration, transaction management, and team workflow.

For the most striking case for an alternative to our current reliance on email, one need only look at the typical transaction, which creates on average 1,000 emails. Indeed, for the high value, income-generating human assets of these organizations – such as traders, brokers, ship agents, and ship owners – exchanging millions of internal and external

emails each day, using antiquated software systems is no longer fit for purpose.

The fundamental flaw derives from the fact that email-based tools, such as Outlook are centered around the individual and designed for personal use, rather than the team. In contrast, the latest Software-as-a-Service (SAAS) communication platforms are designed for teams. They create value by bringing multiple people together and providing a platform for them to work in a far more collaborative, frictionless, fast, and productive fashion, to achieve shared business objectives. This is particularly critical for traders and brokers, who rely on streamlined communication and transaction management within and between teams.

So how do we explain our reliance on tools like Outlook, which is now over 20 years old? Tools like Outlook are so commonplace that businesses have become conditioned into assuming they are the best on the market – or even the only option. However, there are alternatives that support a team-focused approach to transaction management, offering organisations the opportunity to embrace digital transformation in a way that makes sense

for their business, reducing costs and increasing profitability.

Moreover, the relatively sluggish speed of email systems such as Outlook mean they are increasingly unable to meet the requirements of modern, fast-moving businesses that rely upon quick, transparent, and decluttered communication, within and between teams, across multiple locations, in order to optimize profitability.

### Meeting the needs of modern business

A huge part of embracing new streamlined communication, document organization and task management is lightning-fast search capacity. Unlike older systems such as Outlook, new SAAS platforms can search tens of millions of emails in seconds, improving work processes for end users and their managers and saving on average 30% of user time.

They are also compatible and easy to integrate with existing systems and tools, thereby leveraging customers’ current technology investments while being quick and simple to set-up as part of the users’ working environment. This avoids the time and costs of a more complicated installation, eliciting fewer complaints and

‘chaser’ correspondence from customers and individuals that are part of the internal approval and transactional process.

And while the notion of eradicating time-consuming manual processes related to organising, coordinating and completing a transaction is the real ‘dollars and cents’ game-changer, other benefits such as full transparency and accountability, improved data security and significantly reduced risk of delays, mistakes and fraud further reduces time and improves business performance.

Our data shows that using these new SAAS tools can reduce the cumulative time of the personnel involved in a single transaction within an organization by 60 minutes. For a company with a 100-strong trading or broking team, this time saved could equate to a financial saving of \$1.35m per annum. What’s more, these are not theoretical calculations. Leading shippers, owners and brokers such as Glencore, Seaspans, and Monson are already using this technology to drive new levels of efficiency into their operations. For an industry trading more than \$4 trillion in goods each year, this is just the tip of the iceberg.

# INTERFERRY

## 43rd ANNUAL INTERFERRY CONFERENCE

### SAFETY, SECURITY & ENVIRONMENT

# CANCUN

## OCT. 6-10, 2018

**CEO**



CORRIGAN

**KEYNOTE SPEAKERS**

- Mike Corrigan, Interferry
- CDR Ben Lofstad, NATO
- Mark Sutcliffe, CSO Alliance
- Robin Silvester, Port of Vancouver





LOFSTAD   SUTCLIFFE   SILVESTER





carus   DNV·GL

SPONSORS

PLATINUM

PRESIDENT'S

GOLD

SILVER

BRONZE

HAPPY HOURS

LANYARDS

SPEAKER GIFTS

DELEGATE APP

MEDIA

InterferryConference.com
Interferry.com
@InterferryOrg

We are assembling a world-class speakers program that will address current topics and issues relevant to the ferry industry, expanding on our theme of Safety, Security and the Environment.

Our three keynote speakers are CDR Ben Lofstad of NATO, Robin Silvester of the Port of Vancouver and Mark Sutcliffe of CSO Alliance – Maritime.

The full program will include networking events, a Technical Tour, the Carus Cup golf tournament, host-sponsored activities at Aquaworld and amazing tours including Tulum and Isla Mujeres.



Yohei Sasakawa, Chairman, Nippon Foundation



Photo: Nippon Foundation

---

# SASAKAWA

## Chairman, Nippon Foundation

Nippon Foundation is a philanthropic organization active globally with a simple mission, social innovation. While its activities today cross many activities and borders, when founded in 1962 its efforts focused largely on the maritime and shipping fields. Last month in Houston we spoke with Nippon Foundation Chairman Yohei Sasakawa, focused specifically on Nippon Foundation's activities in and around the world's oceans.

**BY GREG TRAUTHWEIN**

**Please explain the most important activities today for the Nippon Foundation, and specifically, discuss the importance of the oceans in your work.**

Let's first start from talking from the grand view, in general, in terms of why I deem the ocean to be important. Looking specifically at the Nippon Foundation, the activities of the Nippon Foundation are related mostly to humanitarian aid and support, globally. We focus on ocean because it is directly related to the sustainability of the human life on earth. Today we live in speedy times; everything moves quickly, and people tend to focus on what might happen tomorrow or maybe 10 years from now at the best. But if you think about the health and the sustainability of the ocean, this is directly related to whether the humans will be

able to live their life on earth 5,000 years from now. These are the bigger, longer span questions that we keep in mind of when living our lives, because the ocean is in danger, especially from over-fishing and the various other problems around the globe.

We know more about the topography of Mars, which is 15 million km away, than we know about the topography of the bottom of the sea. We feel that we also need to start focusing on problems relative to ocean.

**So how would you describe the importance of the Nippon Foundation's work to promote ocean governance?**

Looking from the global aspect, as I mentioned, the ocean is something that will help determine the sustainability of

human lives in the future. Looking at the ocean as a whole, although 70 percent of earth is covered by sea (and most of that is open sea), there isn't a global leader to oversee this entire ocean from a comprehensive perspective from the standpoint of governance or management of the seas.

I have been saying that we need to have some kind of organizational system in which the comprehensive management and governance would be put in place for this vast amount of the sea that surrounds us, from a sustainability standpoint. Many people say "sustainable development," but this usually is for a span of 10 to 20 years. We feel that there should be much longer span that needs to be applied if we talk about the sea, and at the same time to define what exactly the scope of this sustainability is

all about, in order to save the seas that surround us. I have been preaching the importance of this often.

**What are the next steps for the Nippon Foundation in terms of ocean governance?**

We feel that the human capacity building is essential, to educate people and having the expertise to manage this ocean (from a global perspective). For the last 30 years we have been educating 1,200 people from 140 different countries, educating from the standpoint of expert capacity-building. Scientific knowledge, such as measurements for the topography and bathometric chart-making, is essential. At the same time, (this creates) educated people who would be able to run the maritime, or port, related to the

As the oceans play a critical role in human existence, Nippon Foundation and Chairman Sasakawa look at Ocean Sustainability through a much longer lens – 5,000 years from now – and plan accordingly. **Comprehensive ocean governance, education, international cooperation and scientific data are the path to healthy oceans.**





sea agendas. And having these experts in place, we feel that these people would now be able to collaborate in a cross-border manner in order to build more of a comprehensive system, or organization, in order to be responsible to oversee the oceans around the world.

**In Houston at OTC Nippon Foundation signed an MOU with Deep Star. What is the significance of this MOU?**

Starting from more of a hands-on level, it has to do with the natural resources that are scarce in Japan. As you know, in Japan we do not have any oil or natural gas that we can rely on from our land, but recently, the new discoveries were made that there are some rare metals, as well as other resources, that lies down below in the sea surrounding the archipelago of Japan. At the same time, we do not have the means or the technology to extract those resources. So this is something

that Japan will have to acquire, as soon as possible, in order to leverage those resources.

Japan is well known for having sophisticated technology, in areas such as robotics and artificial intelligence. When it comes to Deep Star, they are well-known in terms of working in the field, hands-on. So from that standpoint, we feel that the younger generation of Japan would be able to have the opportunity to be further educated and trained, together with Deep Star, to acquire the necessary capabilities that will be instrumental in the future. We feel that by collaborating with Deep Star will provide a lower cost and safer way to rely on the oil and natural gases from the seabed that surrounds the archipelago of Japan.

**How does this contribute to the future of the oceans?**

The long-term future of human life depends on healthy oceans. And I think that as oil and natural





**Adhesive-Bonded Fastener Technology**

## The Ideal Solution for Late-Stage Outfitting

- > Maximizes Design & Work Sequence Flexibility
- > Eliminates Welding & Gas Freeing
- > Protects Against Galvanic Corrosion
- > Reduces Drilled Holes









Featured Products are ABS and Lloyd's Register Type Approved





Visit Us at Booth #143 Hall B8  
**SMM**  
September 4-7  
HAMBURG, GERMANY

[WWW.CLICKBOND.COM/MR12](http://WWW.CLICKBOND.COM/MR12)

**PIONEERING > ADVANCED > SOLUTIONS**

2151 Lockheed Way Carson City NV 89706 +1-775-885-8000



# “Take me out to the Ballgame ...”

In Houston @ the Offshore Technology Conference (OTC), Japan’s Nippon Foundation started May 1 by signing an MOU with Deepstar, and ended the day at Minute Maid Park to watch the Houston Astros play the New York Yankees at the JSMEA & *Maritime Reporter & Engineering News* co-hosted reception. Nippon Foundation Chairman Yohei Sasakawa had the honor of throwing out the first pitch.





gases on land start to deplete, we have to look below the sea. There has to be technology to do this safer and at a low cost, extracting resources in an accurate manner. So it is important to extract the resources accurately and safely to help maintain a healthy ocean.

When I visited the Johnson Space Center, I noticed that they already have a very detailed topography – the map of the Mars that are 15 million kilometers away from this earth already. But we still do not have the topographic chart – the seabed bathometric chart – for our earth. So we are targeting 2030\* as a landmark year for us to be able to complete the project to (create this seabed chart), to identify where resources may lie, and at the same time help the potential of the further exploration in the future of the required resources for the livings of the people in a more effective, safer manner. These are the kind of things we need to know about the globe that we live on. (\*Seabed 2030 is a collaborative project between the Nippon Foundation and GEBCO, aiming to bring together available bathymetric data to produce the definitive map of the world ocean floor by 2030 and make it available to all.)

**Just one more question. When you look at all of the threats to the ocean today, is there one that stands out?**

It is quite difficult to name only one particular threat when it comes to what's happening in the seas; therefore, I would say there are many threats that endanger the life under the sea. I have visited 125 countries around the world in my life, and when it comes to the problems in the sea, it is not only the problems that come from the developed countries, but there are a lot of developing countries that contribute to that threat, as well.

The plastics that you have mentioned, as well as the PVCs – the vinyls – those are flowing into the sea and being eaten by many of the lives that's living in the seas. Recently there was news talking about shrimp that live 4,000 meters below the sea eating some plastics, with tiny little particles of the plastics discovered in the stomach of these shrimp. If these little lives are polluted with plastics, if you think of the chain of the ecosystem, the larger fish, when they eat these shrimps, would also be endangered. So this is greatly impacting the entire ecosystems of the fish chain down below the sea.

Another threat that we see is the acidification of waters, which has already started and is affecting the life of the sea. You also see global warming affecting

the migration of schools of fish, which affects the lives of these people who are reliant on the life under the sea.

So just thinking of all these together, if we lose the life of the fish from the sea, many people on the earth are actually

eating these fish as their staple food, so the people would not be able to sustain their livings. So from that sense, we feel that there is a tremendous urgent importance in retaining and sustaining these ecosystems that are prevalent in the sea.

A growing world population, overfishing of the seas and climate change are all affecting greatly of the lives in the seas. So I think that the age has come in which people would now have to start protecting the oceans.



## Progress Locked-IN Self Actuating ISO Container Lift Spreaders

- **Non-Powered, Semi-Automatic Operation**
  - Mechanical Gearbox provides operational confidence
- **Crane Operator Engages & Disengages**
  - No Ground Personnel Required
- **Superior Corrosion Resistance**
  - Zinc Thermal Spray Undercoat
  - Marine Quality Epoxy Paint



**www.TANDEMLOC.com**  
Toll-Free Tel: 1-800-258-7324  
International Tel: (252) 447-7155  
info@tandemloc.com

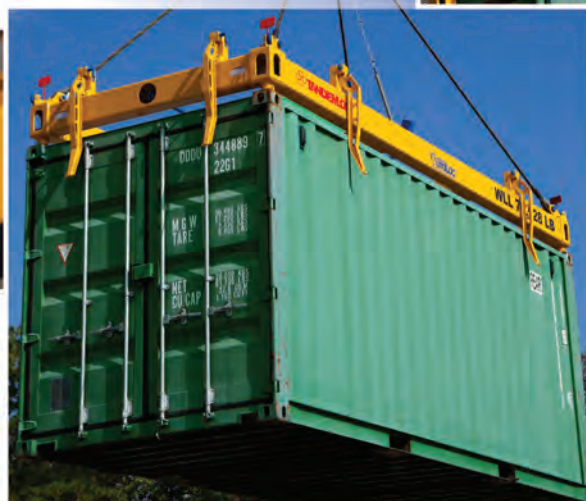

Promo Code for 5% off: **MREP18**

## POSEIDON® P2 PORTABLE SECTIONAL BARGES

- | Size                      | Weight      |
|---------------------------|-------------|
| • 40' x 10' x 7'.....     | 31,207 lbs. |
| • 20' x 10' x 7'.....     | 16,587 lbs. |
| • Spud Pockets.....       | 4,350 lbs.  |
| • 10' x 10' x 7' Rakes:.. | 7,732 lbs.  |
| • 20' x 10' x 7' Ramps... | 12,150 lbs. |

Patented roll form deck capable of 20,000 psf point load - 4X's stronger than the competition!

The world's **ONLY A.B.S Certified Portable** Sectional Barge Design.  
Call 866-992-2743 for more info!



### POSEIDON BARGE, LTD

725 E. Parr Road, Berne, IN 46711  
PH: 866-99-BARGE; FAX: 260-424-8635  
WEBSITE: [www.poseidonbarge.com](http://www.poseidonbarge.com)

STOCK LOCATIONS: Berne, IN • Plain, WI • Leland, NC  
Cocoa, FL • Wilton, NY • St. Louis, MO • New Orleans, LA



## Green Marine: Coatings

# Fighting Nature with Nature

# New Research in Biofilms

Credit: Maria Salta

---

By Kira Coley

---

Underneath the glistening patchwork of blues and greens lurks an intricate world of unique animal communities, diverse landscapes, and changeable conditions. The ocean is also one of the most extraordinary and fascinating ecosystems on the planet – a place that can host both the source of a problem and the solution. In the maritime sector, an estimated US\$56 million a year is associated with biofouling for the US Navy alone. Anti-fouling coatings have the potential to reduce millions of tons of greenhouse emissions each year, but the industry is yet to find an effective method that is also environmentally friendly. Dr. Maria Salta, an environmental microbiologist at the UK's University of Portsmouth

is exploring how nature's ability to self-clean might hold the secrets we need to keep moving and static structures foul free. If successful, not only will she save the shipping industry millions, but help protect the planet from further exposure to toxic substances from which marine communities still suffer the impact of today.

Anti-fouling coatings reduce 384 million tons of carbon dioxide and 3.6 million tons of sulfur dioxide each year. The International Maritime Organization estimates that without corrective action and the introduction of new antifouling technologies, greenhouse gas emissions could increase around 38 percent to 72 percent by 2020.

For over 30 years Tributyltin (TBT) was the active agent in antifouling paints used extensively in the maritime sector. It wasn't until the 1980s that it was realized to be one of the most harmful substances knowingly introduced into the marine environment. TBT was causing severe damage to non-target animals in the wider marine environment, such as deformities in shellfish and mollusk communities, reduced growth of algae and toxic effects in young fish.

Dr. Maria Salta is an expert in marine biofilms with a particular research interest in environmentally friendly anti-fouling coatings. "Until 2003, the maritime industry was using TBT which was successful but a very toxic substance. It was

acting against non-target animals, and along with many other side effects, it was changing their sex. The toxins from TBT have been accumulating in the water and sediments since it was first used in the industry in the mid-60s. It took over 30 years to ban it entirely, but by then it already did a lot of irreversible damage."

Salta's research explores solutions that mimic natural systems to stop marine growth on ship hulls. Scientists have studied in microscopic detail what makes the skin of whales, sharks, and some other marine creatures capable of deterring barnacles, mussels, and algae which attach to human-made structures left in the sea for an extended period of

## Encrusting biofouling organisms on a metallic surface.

time. While the first layer of colonization (biofilms) are hugely important, it is often ignored in research.

Salta explains, “Biofilms (aka slime) are the first layer of colonization made up mainly of diatoms and bacteria. Many people believe this layer is the first to form on a surface but also acts as a food source for larger organisms, such as spores and larvae, that eventually firmly attach. The biofilm alone can cause up to 18 percent of fuel penalty with less than 1-millimeter thickness. So, not only is it a food source but creates huge issues by themselves including surface roughness that impacts the hydrodynamics of the ship, pitting and biocorrosion of marine pipelines, aquaculture and more – not just ships.”

Biofouling affects all human-made objects in the aquatic environment. For Salta, finding a solution meant she must first find ways to remove the biofilm. “It’s fascinating because it is such a dynamic micro-community with so many different organisms. In fact, for algae and barnacles – which are the main issue when it comes to shipping – the maritime industry does have some methods to cope with this problem. They use silicone based coatings very much like the non-stick surfaces found on our frying pans. The organisms attach, but when the ship starts moving, they fall off. This is an excellent tactic, but works better at high speeds and not at all effective for static objects. On top of that, the biofilm is still there causing havoc.”

Through her research, Salta has now developed a range of innovative techniques to test various antifouling coatings, materials and fouling behaviors in the laboratory that simulate natural conditions. “There was a gap in these techniques for a long time until now, and in many respects, people are still using basic methods. For example, when testing antifouling materials, scientists often do it in a static environment – although informative, it doesn’t represent the real environment as biofilms are always exposed to flow. Even if the ships aren’t moving there are tides, so they are never truly ‘static.’ I developed a new method that incorporates hydrodynamics so I can see what happens when biofilms are under flow that would be more representative of the natural environment. I have also developed high-throughput methods that assess how biofilms form directly on experimental and commercial coatings.” said Salta.

“We also now know that biofilms prefer to attach to some surfaces more than others. The problem is that often bacte-

ria adapt – if you modified the surface properties, the bacteria could potentially modify themselves to overcome the barriers. We don’t know how or why and to what extent microorganisms adapt ac-

ording to the surface, so as part of my research we’re looking at species-material associations. New results came out recently and they look exciting. But before we can prevent biofouling we

first need to understand biofilms – why are these microorganisms attaching to where they are attaching and how? And then we’ll find a solution in parallel to that research.”



Photo courtesy of Color Line

## BIGGEST HYBRID FERRY TO DATE

DNV GL is the world’s leading classification society and a recognized advisor for the maritime industry. We have developed class notation - Battery (power) for use of maritime batteries on ships like Color Hybrid. She is the biggest hybrid ferry to date with an innovative hull design and a powerful battery pack on board, utilizing a plug-in hybrid and diesel electric power. Besides zero-emission operations, it emits extremely low noise during battery operation and overnight port stays.

Find out how our DNV GL experts can turn possibilities into opportunities - and make your operations safer, smarter and greener. Learn more at [www.dnvgl.us/maritime](http://www.dnvgl.us/maritime)

SAFER, SMARTER, GREENER

DNV GL

## TRANSAS

UNIQUE  
INTEGRATED  
INFRASTRUCTURE

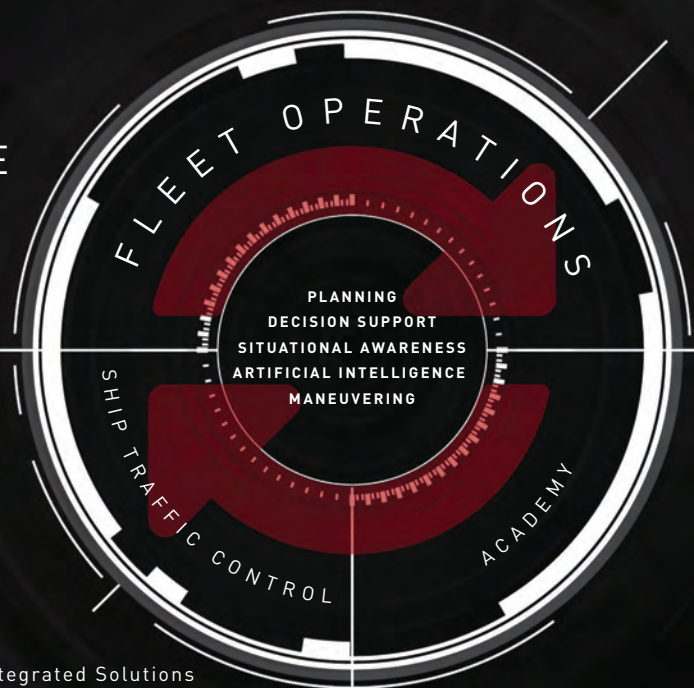

THESIS | Transas Harmonized Eco System of Integrated Solutions  
[info@transas.com](mailto:info@transas.com) | [www.transas.com](http://www.transas.com)



Credit: Maria Salta

## Biofouling organisms on a plastic surface (mussels, algae and bryozoans).

Salta's work covers a variety of angles including biomimetics and next-generation sequencing "When the muscles are very young, proteins may help them stay foul free. But the solution will not be straightforward because both chemistry and biology are involved. For example, the seaweed is not entirely foul free, it also has bacteria on it. So, do the bacteria play a role in keeping the seaweed free of other biofouling organisms? There are times when this has been shown to be the case.

Large marine animals have also been looked at because of their relatively foul-free existence. New technologies draw inspiration from the surface's shape, and pattern found on marine organisms, such as the shark. For example, the shark's surface works hydrodynamically, and the 'scales' help to create little vortices that in theory work to deter bacteria from

attaching, colonizing, and forming biofilms. Salta explained that these types of technology have had some success; however, they are often short-lived because the biofilm can eventually form a layer over the surface.

After several years of research, Salta has discovered a system from the natural world that could be very promising and eventually used by the antifouling industry. Later this year, she'll be releasing the first results and announcing her findings to the world.

"It is the surface topography that makes this system so exciting: a surface that naturally balances the different types of organisms that are able to interact with it, such that the surface remains foul-free. But first we need to understand it in the natural environment, and then we should have a good idea of how

to replicate it. This is where biology, engineering, and chemistry come in, and this is what I'll be looking out over the next year," said Salta.

"It's such an important topic because the amount of fuel that you need to use to compensate for biofilms alone is very high being both costly to the marine industry but also to the environment in the form of greenhouse gas emissions. If we can solve this problem, then it won't just benefit the shipping industry. You have, offshore energy systems and platforms, aquaculture, autonomous underwater vehicles, sensors, moving and static structures within different marine environments. Massive structures that have to be taken out of the ocean to be cleaned which cost thousands and thousands of pounds and is an arduous process. But we live in exciting times because technology is advancing in major steps. If it

isn't possible now, it might be possible in just five years' time. It's worthwhile developing ideas, so when the technology is finally here, you can achieve amazing things. If we want to find a solution to this problem we need to work together – scientists, engineers, and industry. It's the only way. And the answer lies in nature."

In December 2017, £26 million was invested into launching the National Biofilms Innovation Centre (NBIC) which Salta is also a part of. Led by the University of Southampton, it aims to bring the best of UK biofilm research together with UK companies from across the industrial sectors. Together, the group hopes to propel forward progression for industry and the environment, and discover effective methods to reduce the impacts of this complex, microscopic community.



2

## Objectives:

- Compliance
- Equipment Protection

MEETS  
OR EXCEEDS  
VGP  
REQUIREMENTS

Clarion® Lubricants is committed to your success. That means reducing your risk of regulatory penalties while protecting your equipment and manufacturers' warranties. Let us show you how utilizing applicable Clarion Green BIO and Clarion Green Synthetic products can help you steer clear of fines and downtime.



Visit us at [ClarionEnviroSafety.com](http://ClarionEnviroSafety.com)





**Green Marine: Hybrid Drives**

# Odin's Eye & the *Quiet Trawler*

**BY WILLIAM STOICHEVSKI**

*When it was time for France Pelagique to start renewing its fleet, an electric-power alliance of Dutch and Scandinavian yard interests formed up and delivered. The result was the first installation aboard a trawler of NES's Odin's Eye, a DC grid solution to integrate another first for trawlers — quiet-running permanent magnet, or PM, propulsion.*

Where to begin a fleet modernization that ends with green credentials and richer harvests? Well, there are multiple points of contact, if you opt for a certain Scandinavian electric-power alliance.

That's what France Pelagique and its Dutch owners, Cornelius Vrolijk Group, found when they encountered just such a power alliance in generator-set provider, The Switch; system integrator, Norwegian Electric Systems, or NES, and their collective client, Havyard Ship Technology, a yard and designer with a track record in the design-and-build of offshore and fisheries vessels.

With the European Union demanding power-management systems aboard-ship; with Europe's ports increasingly finicky about who they want quayside, and with seafood consumers seemingly needing some sort of green reassurance, the owner of a new ship has a lot of

concerns. That's why France Pelagique is expecting a lot from the shipbuilding alliance piecing together their 80-meter pelagic trawler.

"This is a very exciting build and no-doubt challenging to the extent that there are a lot of features," Havyard Ship Technologies' Lars Conradi Andersen tells Maritime Reporter & Engineering News. "They're renewing their fleet, so they're into getting the best technology that's available. It's a very modern fishing trawler."

#### **Fast fish**

To catch and process herring, mackerel and blue whiting, the new vessel will sport sustainable-catch equipment and processing equipment from separate suppliers. The speedy mackerel are the stuff of record North Sea catches in recent years. To catch them, you need

speedy, manoeuvrable trawlers on-the-spot when they school or surface to prey on herring.

"With this new fishing vessel, we will strengthen our efforts in future fisheries, with a focus on maintaining healthy fish stocks, reducing environmental impact, and having dedicated and proud employees," a France Pelagique statement said when the order was announced in April. This one, energy-efficient vessel will start the company's fleet renewal by replacing two vessels in service since the '80s.

To do it, Dutch yard ASD has worked together with Havyard, which in-turn brought in some star suppliers. "There was cooperation with ASD which did the initial design for the vessel. The work we have done continues," Andersen says.



Havyard Ship Technology

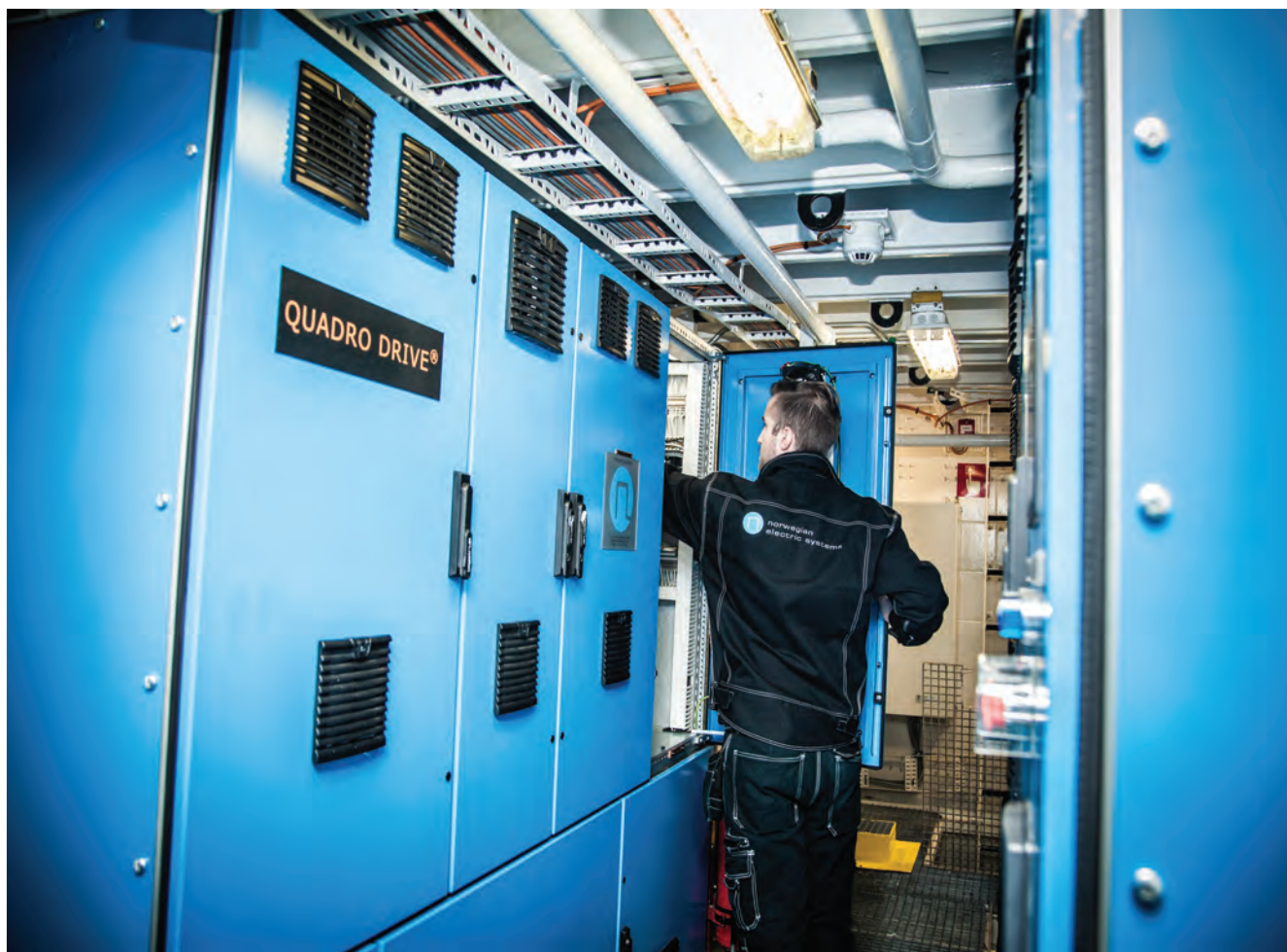

Norwegian Electric System (NES)

Above:  
**Breakthrough vessel:** the mackerel-catching new-build designed by France Pelagique and ASD Ship Design is being built and engineered by Havyard Ship Technology

Left:  
**Odin's Eye:** a DC grid cabinet enables gearless use of the quiet permanent-magnet motors onboard

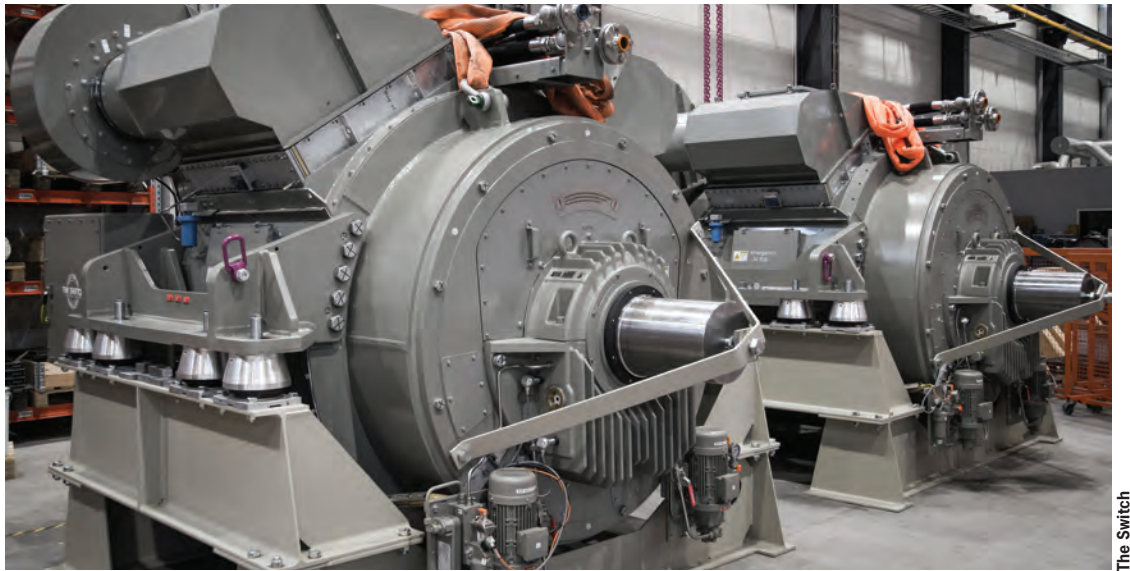

The Switch

*The main decision-making criteria from the customer point of view was the extremely compact size and low weight of our PM machines combined with high-efficiency (an estimated weight saving of more than 40 tons compared to conventional machinery). Combined with the compact physical size of the PM machines, the ship's overall design becomes much easier.*

### **Jussi Paranen, The Switch**

#### **Joint design work**

So, you more or less sent the drawings back and forth? “More or less. They worked on a concept, and when they chose it, we developed it further. It’s part of a process, a working process. We worked together with the owner to decide whose (technology) would deliver, as building with electrical motors isn’t very common on these types of vessels. We spent a lot of time on it together with the owner,” Andersen says. Have you been to France? “We’ve been everywhere,” he says on the phone.”

While crew comforts and working conditions will see a modern upgrade, the build’s crowning achievement appears to be the vessel’s power-management, electrical generators and propulsion

#### **The Switch**

Among the suppliers Havyard brought in was subsidiary, NES, the system integrator for the project, and Finland-based, The Switch — which delivered two permanent magnet (PM), 2,250-kilowatt propulsion motors and two, 3,055 kW permanent-magnet gensets (alternators) for the Bergen-based systems integrator. The Switch was a shoe-in after its factory-acceptance testing in March at Lappeenranta, Finland, revealed only reliability and the breakthroughs made.

Although experienced in geared electric propulsion, the work for NES is The

Switch’s first electric propulsion case for direct-driven permanent magnet motors; its first genset case and first case for a large commercial fishing vessel. Together, propulsion and generators normally mean noise or vibration — a problem for crew and easily spooked fish — but The Switch’s permanent-magnet gensets, with no clanking to speak of and less structural noise overall meant noise could be brought below DNV GL strictures.

#### **Ship magnets**

“The main decision-making criteria from the customer point of view was the extremely compact size and low weight of our PM machines combined with high-efficiency, especially when the ship is moving at low speeds,” says The Switch’s Jussi Paranen, before adding, “On propulsion motors, our competitors were offering conventional-type (asynchronous) machines which had more than double the weight, thus making the weight saving just from the two propulsion motors to be more than 40 tons. Combined with the compact physical size of the PM machines, the ship’s overall design becomes much easier.”

The direct-drive PM machines also showed efficiency gains over conventional motor types of “two to four percent-units” at “the nominal point”. The gains increased at partial loads or low-

speed steaming.

“This means significant fuel savings over the lifetime of the vessel,” Puranen says, adding that demonstrating fuel efficiency raised eyebrows, as the variable-speed genset allows for easily controlled diesel-engine speeds that cut fuel use.

Yet another deciding sales point for a new-build hoping to start trials for the client’s 30th-birthday ceremony was the brief delivery time: “The delivery time of the motors and generators was crucial, and yet we were able to deliver a fully optimized tailor-made design for this specific vessel in very short time.” Finally, The Switch’s motors tested well for thermal behaviour and “exceeded expectations”, as fuel-efficiency testing raised eyebrows.

#### **Norwegian Electrical Systems**

NES confirmed The Switch’s propulsion and power solution was 50-percent more compact than competing arrays. It was 35 t lighter, meaning 35 t of extra fish in the haul and fewer vessels chasing fewer schools of fish.

NES is delivering the frequency converters for the trawler developed by France Pelagique and ADS. The vessel, due on the slip in December, is currently “in hull-construction stage”, Andersen says, adding, as shipbuilders do, that the charterers can still order changes (like the addition of energy storage).

“No battery is to be installed on the new France Pelagique vessel, but it can be easily retrofitted if requested by the owners,” NES’s Paul Winson tells us during an early morning pause on a North American business trip. Winson says the battery retrofits NES recently agreed to do on a series of platform supply vessels were “a challenge” compared to a new-build trawler.

“The new France Pelagique trawler, with its state-of-the-art DC grid (called Odin’s Eye), would be easier to upgrade with batteries than the older PSVs,” he says, adding, that the vessel can be upgraded at a later date.

“NES is the system integrator and not only supplies most of the electrical equipment but is responsible for making sure everything works in harmony and reliably,” Winson says.

#### **Odin’s Eye enabler**

Importantly, NES is delivering its brand new DC Grid solution called Odin’s Eye to the France Pelagique new-build. It has never before been fitted to a fishing vessel, but it’ll uniquely enable the fixed-speed Finnish generators onboard to operate at variable speeds.

“This makes this fishing vessel much more efficient on fuel-use and reduces harmful emissions considerably. Instead of having the generators running at full speed constantly, these ones will be able



to vary the speed and power output to what is actually required, so no excessive waste,” Winson says, adding, “It will also make the vessel much quieter which is more comfortable for the crew and better for catching fish.”

NES has installed electric systems on four other fishing trawlers, but none of those had Odin’s Eye, and the boats had more conventional AC diesel-electric and diesel-mechanical systems aboard. Designed originally for the offshore vessel market’s enhanced safety requirements, the Odin’s Eye adds similar benefits to fisheries vessels. Winson confirms there’s great interest from fishing vessel owners: “Fishing vessel owners are always looking for competitive advantages and are very savvy to the new technologies available.”

The fish-processing equipment on board by GEA is simple to integrate, Winson says. “The trawling solution is a bit more complicated,” as the catch gear comes from a third-party supplier. “We will be supplying the DC power for (the process) equipment, but (the third party) are supplying their own drives and motors for the trawling system.” The unspecified company will supply the vessel’s automation system, so, “They will have better control of their own power requirements.”

#### Industrial breakthrough

Odin’s Eye has been a huge success for NES, and sales are at record levels. “Carbon-neutral” passenger and ro-ro ferries dominate sales in Norway, where the public purse and political will exist to build purely electric ferries.

“Electrically, the new ferries are not much different in sophistication than the new French Pelagique vessel. The major difference is in the supply of electrical power.

The French Pelagique vessel has diesel generator sets and the new ferries have batteries,” he says, adding that batteries make things more complex. Havyard’s Andersen agrees, adding that even without a battery, “This (trawler) is special because the complexity is quite high, and it has an advanced processing system on-board.”

#### Silent-silent mode

With an option for a second vessel already aired, it’s easy to think this has been just another order. Yet all the parties — from the owner on down — see this build as unique and a potential game-changer for the industry.

As Havyard marks its 100th Year, The Switch will be thinking Business Case No. 2 and beyond. After running PM gensets on R&D trial runs for a couple of years, they’re keen to show the val-

ue of their PM propulsion and gensets: “This is a significant milestone not just for us but for the whole PM machine industry, since traditionally such silent vessels have used either DC or conventional AC propulsion motors to keep the underwater radiated noise level as low as possible,” Puranen says, adding that hav-

ing met DNV GL’s “silent-trawl” Silent F rules for noise means vessels like pelagic trawlers, research ships and naval assets can sport silent main propulsion systems driven by compact, efficient, low-maintenance PM motors.

“Even before meeting us, the shipyard wanted to use PM machines,” Puranen

says, before launching into maintenance savings. “Brushless PM machines need minimal maintenance, as basically the only wearing parts are the bearings and cooling fan motors. Also, the reliability is excellent, because the moving part (rotor) is extremely simple, and the risk of mechanical failure is minimal.”

**FIRE SUPPRESSION & FIRE DETECTION SYSTEMS**  
For USCG Compliance

**FIREBOY-XINTEX**  
A Darley Company

Clean Agent Fixed Fire Suppression Systems up to 17,500 cu. ft.

Elite RSM

Alarm Strobe

Smoke Detector

fireboy-xintex.com

**W&O INTRODUCES**  
**SeaCor**<sup>®</sup>  
by GF Piping Systems

**YOUR SOURCE FOR THE FIRST USCG APPROVED MARINE THERMOPLASTIC PIPING SYSTEM.**

W&O is the proud North American distributor for the groundbreaking SeaCor piping systems from Georg Fischer – the first and most widely accepted United States Coast Guard-Approved (USCG) marine thermoplastic piping system in the world.

SeaCor is the only thermoplastic piping system that meets the requirements of Transport Canada as well as the February 2017 Canadian Vessel Fire Safety Regulation (VFSR).

Light in weight and long-lasting, the corrosion-resistant SeaCor piping system is a unique, cost-saving solution to optimize vessel performance.

**W&O**

+1 800.962.9696 | wosupply.com

**Pipe | Valves | Fittings | Actuation | Engineered Solutions**



# Zero Emissions

**The all-electric, zero-emission  
Future (of The Fjords) has arrived**



Future of the Fjords, the world's first all-electric and completely emissions-free ship, was launched in April this year by Norwegian tours operator The Fjords, and is now operating as a cruise vessel on the spectacular Gudvangen to Flåm route along the Nærøyfjord, Sognefjord and Aurlandsfjord of western Norway. *Maritime Reporter & Engineering News'* science & technology writer, **Tom Mulligan**, recently rode the route and had a peek under the hood at some revolutionary marine technology.



**Under the skin, this new craft is a different beast. We now hope Future of the Fjords can become a benchmark for environmentally responsible vessel operators worldwide, ushering in a new breed of clean, green and spectacular passenger transportation.**

**Rolf Sandvik, CEO, The Fjords**

## Future of The Fjords

was commissioned as part of the shipowner's program of fleet renewal with the backing of Fjord1, the largest ferry operator in Norway, and of Flåm AS, the company that promotes tourism in the Flåm area, to provide vessels that deliver optimal passenger experiences with minimal environmental impact.

Constructed by specialist shipbuilder Brødrene Aa, the new vessel retains the eye-catching 'mountain path' design and environmentally-friendly build of its sister ship Vision of the Fjords, a hybrid diesel-electric vessel, with a hull that minimizes wake and reduces shoreline impact erosion. The Power Dock, the ship's revolutionary floating charging station, which was also developed in partnership with Brødrene Aa, takes on gray and black water to ensure no sewage discharge into the pristine waters between Gudvangen and Flåm. Future of The Fjords also offers up to 400 passengers spectacular panoramic views of the western Norwegian fjords, with a guaranteed one meter each of railing on deck for a unique 'front-row' experience of nature.

According to The Fjords CEO Rolf Sandvik, the ship's similarities with Vision of the Fjords stop with its outer design and the scenery on offer to its passengers:

"Under the skin, this new craft is a different beast," he said. "Vision of the Fjords switches from diesel to electric power when journeying along the UNESCO World Heritage listed Nærøfjord. It represented an important step forward on our journey to transform tourism in this delicate natural wonderland, but this new ship is, quite simply, our dream come true. It marks the fulfilment of a vision. It is our mission to safeguard the vulnerable environment we give access to, while providing the absolute optimal experience for our passengers. With Future of The Fjords it is mission accomplished. We now hope Future of the Fjords can become a benchmark for environmentally responsible vessel operators worldwide, ushering in a new breed of clean, green and spectacular passenger transportation."

Sandvik continued: "Future of The Fjords not only provides an optimal passenger experience, with the only noise being the fjords' natural soundtrack, but it also showcases a new, zero-emissions way to enjoy and safeguard this fragile landscape. The vessel is totally different from anything else on the water, showing what can be achieved with the determination, investment and ambition to operate responsibly

and sustainably. We want this to be a paradigm for the industry. We believe this really is the future of the fjords."

### Industry Leaders' Collaboration

Future of The Fjords, which took its first passengers through the UNESCO World Heritage listed Nærøfjord on May 15 this year, was conceived, developed and constructed through a collaboration between leading industry players, each contributing its individual competencies to provide the key pieces of this environmentally responsible vessel.

The new DNV GL classed 'light craft' is propelled by two 450 kW electric motors, enabling cruising speeds of 16 knots. In addition to its advanced propulsion system, Future of the Fjords features upgraded IT systems to ensure that the ship meets modern digital demands. The vessel also features a restaurant and high comfort levels.

"Vision of The Fjords was an important development for us, but we had the ambition to take it one step further and replace the diesel-electric propulsion system with an all-electric one," added Sandvik. "Taking this delivery is a very proud day for us, and for our progressive owners Fjord1 and Flåm AS. By introducing another vessel of this class, we are also able to expand the premium capacity on this special waterway. That leads to some economy of scale and will help keep ticket prices at very attractive levels. We want everyone to have the opportunity to experience the Future of The Fjords."

The ship cost NOK 144 million (about \$17 million), marking a significant increase over the NOK 90 million (about \$10.6 million) price tag of Vision of the Fjords. Much of the extra investment is the result of opting for an all-electric solution. Enova, an organization promoting low-emissions solutions backed by the Norwegian Ministry of Petroleum and Energy, provided NOK 17.8 million funding (about \$2.2 million) in support of the project.

### Innovative charging solution

The Power Dock charging solution developed jointly by The Fjords and Brødrene Aa, is a 40-meter long, 5-meter wide floating glass fiber dock that sits in the water at Gudvangen, housing a 2.4 MWh battery pack. This charges steadily throughout the day via connection to the local grid network, which does not have the capacity to charge Future of The Fjords directly. The innovative solution allows the vessel to stably, efficiently and cost-effectively 'refill' in 20

### Future of The Fjords Technical Specs

Shipbuilder	Brødrene Aa
Building material	Carbon-fiber sandwich/ Vinylester
Vessel type	Passenger catamaran
Hull No.	291
Flag	NOR Fartsområde 2
Class	DNVGL 1A1 HSLC R5 Passenger
Passenger capacity	400
IMO Number	9830214

### Dimensions

Length o.a.	42.49 m
Length p.p.	40.85 m
Beam o.a.	15.2 m
Gross tonnage	770

### Tank Capacities

Fresh water	1x 3000 liter
Gray water	1x 2000 liter
Black water	1x 3000 liter
Bilge water	1x 200 liter

### Engines & Propulsion

Main engines (Electrical)	2x Ramme 450 kW
Propulsion system	Servogear Ecoflow Propulsion
Reduction gearbox	Servogear HD220
Bowthruster	2x Sleipner SAC350
Stern thruster	2x Sleipner SAC450
Battery installations	ZEM – 1800 kWh Lithium ion
Power management	Westcon Power & Automation

### Deck equipment

Anchor system	MB Hydraulikk 1-AV-24K2 / SEC Anchor 237 kg/Mørenot
Gangways	Brødrene Aa

### Interior

Passenger seats	West Mekan
Seats bridge	Alu Design 540
Flooring	Nordic flooring / Egetepper
Toilets	Jets Sanitary System
Evacuation system	Survitec

### Systems

Nav and electronics	Landor Larsen/Brødrene Aa
Fire safety	Nortronik
HVAC	Naustdal Blikk



Image Courtesy of Brødrene Aa

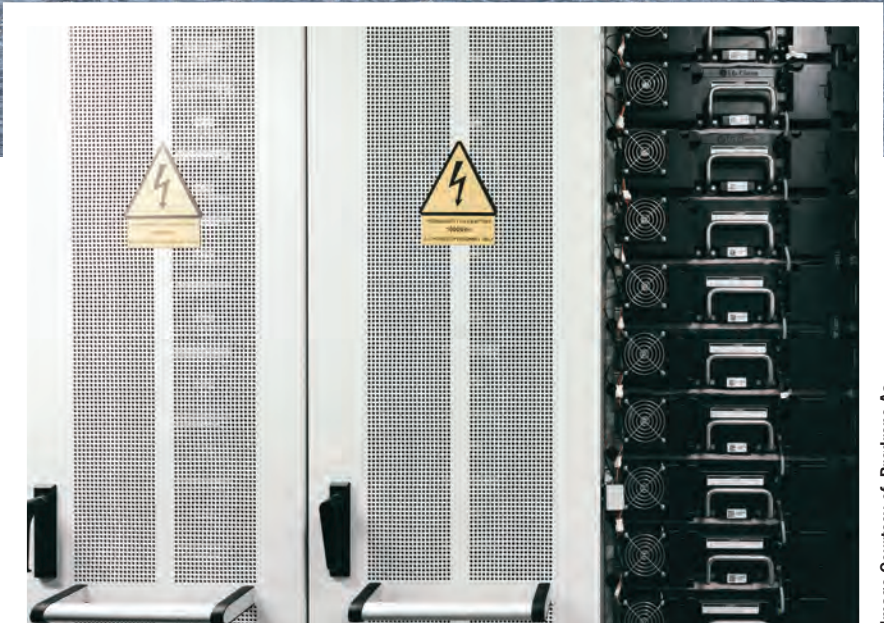

Image Courtesy of Brødrene Aa

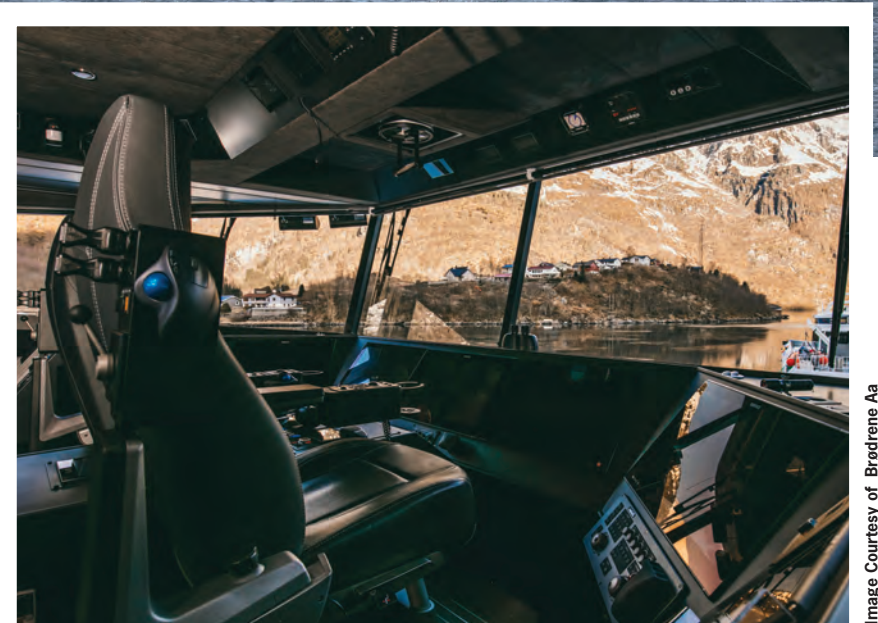

Image Courtesy of Brødrene Aa



Image Courtesy of Brødrene Aa



Image Courtesy The Fjords

minutes. The Power Dock also stores consumables and fuel for sister vessels, and allows black water to be offloaded for treatment on land. This makes Future of The Fjords the only passenger vessel not to discharge sewage directly into the fjords.

### “An important leap forward”

“This is a big and important leap forward in the ongoing maritime battery revolution, with The Fjords now taking us one step closer to an emission-free transport sector,” commented Petter Hersleth, marketing manager at Enova. “We believe that Future of the Fjords will help inspire the travel industry to adopt battery-powered vessels faster, both here in Norway and abroad.”

Norwegian-headquartered environmental campaigner Bellona also supported the project: Frederic Hauge, Bellona’s founder and president, said the new ship marked a “fantastic” development for tourism in the region and stated that the Fjords vessels were “an example to follow for the rest of the industry.”

He added that tighter regulations from both national and local authorities were now required to protect the area, noting: “We must dare to define requirements regarding how our precious World Heritage fjords are managed and experienced. In the future, tourists coming to see our pristine nature will not accept anything less than emission-free experiences. The Fjords is now demonstrating that this is possible, from both an operational and business perspective.”



Image Courtesy The Fjords

**The Power Dock, the ship’s revolutionary floating charging station, which was also developed in partnership with Brødrene Aa, takes on gray and black water to ensure no sewage discharge into the pristine waters between Gudvangen and Flåm.**



Image Courtesy of Brødrene Aa

## Companies with Vision: Fjord1 AS and Flåm AS

### Fjord1 AS

Fjord1 AS is one of the major transportation companies in Norway with a core operational area in sea-based transportation by ferries and passenger vessels. In addition, the company has operations in the areas of catering, travel agency services and property management. Fjord1 AS is owned by Havila AS and the County Council of Sogn and Fjordane. F

### Flåm AS

Flåm AS is a provider of tourist attractions in the fjords and mountains of western Norway and is the global marketing and sales arm of the Flåm tourist business cluster which includes world-recognized attractions such as the Flåmsbana railroad and The Fjords’ cruises in UNESCO World Heritage fjords. Flåm AS is owned by SIVA, a Norwegian state business development company, Aurland municipality and Aurland Savings Bank.

## Key Partners in Future of The Fjords

### Brødrene Aa

A leader in designing and building passenger ships from carbon-fiber composites, Norwegian shipyard Brødrene Aa created the iconic design of Vision of The Fjords and Future of The Fjords, and designed and constructed the innovative Power Dock.

### DNV GL

Classification society DNV GL was on hand throughout the project to provide advisory and class services (classing the vessel as a ‘light craft’), using its expertise to guide the collaborators through the entire compliance process and deliver technical insight.

### Enova

Enova is a Norwegian organization promoting low-emission solutions, and is backed by the Norwegian Ministry of Climate and Environment. Future of The Fjord’s all-electric propulsion solution pushed the cost of the vessel to NOK 54 million (about \$6.4 million) above that of its sister ship. Enova provided NOK 17.8 million funding (about \$2.2 million) to help make the vessel a reality. In addition, the organization provided funding of NOK 6.9 million (about \$850,000) for the Power Dock solution.

### Bellona

The Bellona Foundation is an international NGO working to combat climate change through identifying and promoting environmentally sustainable solutions. Bellona acted as a project consultant and supporter, with Future of The Fjords complementing the organization’s long-standing mission to move the maritime industry towards zero-emission transportation.

### Westcon Power & Automation

Independent systems integrator Westcon tailored the vessels’ all-electric propulsion and battery system to comply with the stringent environmental and operational demands of The Fjords.

# A CRUISE SHIP THAT MOVES THOUSANDS OF PASSENGERS

And a large-scale project where we were  
on board from the beginning

Why does the world-renowned Meyer Werft shipyard team up with Viega time and again for numerous projects of this scale? In addition to the extremely reliable piping systems made from copper, copper alloys or plastic materials, Viega also supplies the know-how to go with them. **Viega. Connected in quality.**

Meyer Werft shipyard, Papenburg, Germany

**viega**



***For more than a decade Dubai has been ‘emerging’ as a maritime hub. Through a variety of ups and downs, twists and turns, today it features more than 5,500 companies in the maritime sector. Dubai is no longer emerging; Dubai has arrived.***

## BY MARK VENABLES

Dubai historically has been a leading trading port in the Arabian Gulf, and now the UAE Government is determined that the country continues to be a hub for the world. Dubai itself is striving to become one of the world’s top shipping destinations through its Maritime Vision 2030 that it launched four years ago. The maritime sector is expected to be worth \$66B to the emirate by 2018, according to Oxford Business Group, with further investment planned for the established Jebel Ali Port and ongoing development

at the two million sq. m. new free zone, Dubai Maritime City. Charged with delivering these ambitions is the Dubai Maritime Cluster, part of the Dubai Maritime City Authority (DMCA), established in 2007 to monitor, develop and promote maritime activities while offering investment opportunities to boost Dubai’s competitiveness.

### **Rising Through the Ranks**

*The Leading Maritime Capitals of the World of 2017* report published by

Menon Research and DNV GL was announced in Singapore late last year ranked Dubai at number 10 overall. “When we launched the strategy four years ago, Dubai was not even in the top 10, but five years into our hard work to manufacture a product that could be attractive to the shipping community, look where we are today,” Nawfal Al-Jourani, Chief Officer – Dubai Maritime Cluster explains. “In terms of attractiveness and competitiveness Dubai is number five globally. In terms of the overall ranking

as a shipping center we are at number 10.

“They asked 1,600 professionals from the maritime community all over the world what is the most important or attractive overall global maritime center of the future, Dubai jumps to sixth overall. This is a vote of confidence. It is important to us as it is a vote from the very community that we are trying to attract.”

Al-Jourani explains that the strategic direction is very simple; they want to be a leading global maritime center. “For that what we are trying to do is to devel-





Credit: Dubai Maritime Cluster Office



Photo: Goltens

**Goltens operates a 10,000sq. m. facility within the Dubai Maritime City (DMC).**



Photo: DNV GL

**DNV GL notes a rebound in the region's offshore energy business.**

op, regulate and promote what Dubai has to offer," he says. "We know that there are other cities around the world that are doing the same, but that will always be the case.

"I always say that we compete against ourselves; that is the most important thing that we challenge the status quo every day. What type of regulation makes the shipowners life easier? What kind of financial guidelines do we need to put in place to attract them to come here? What human resources regulations? What type of criminal law justice system? I'm sure if you look at these things you will see why Dubai is way ahead in this region. This is what we mean by a world-leading maritime sector."

Another huge boost for the region came in December when the UAE became the only Arabic nation to ever win a seat on the IMO council in category B. That, according to Al-Jourani, was vital

as the region can now have a direct influence on business and regulations. "The IMO is talking about ballast water management, sulphur emission deadlines," he continues. "Imagine a room where these 10 nations sit and decide on these things. We didn't have a voice before, now we have so we can now say what works and what doesn't work."

#### Reasons to be Cheerful

One of the key components of the maritime sector in Dubai is the oil and gas industry, which has taken a big hit since the oil price crashed several years ago. According to Geir Fuglerud, Area Manager, Middle East and Africa at DNV GL, that sector has hit the bottom and there is a renewed optimism. "We see within DNV GL, more requests for quotation, more business happening, rigs coming out of lay-up, vessels are being reactivated," he says. "It is not moving

quickly, but there is a positive trend to it."

Even though Dubai has climbed the rankings as a maritime cluster there is still an area that causes concern to Fuglerud. That involves innovation. Out of the top 15 maritime capitals, Dubai was rock bottom when it came to research. "They have a way to go and there is a big appetite to improve," he says. "This study came out seven months ago and I am impressed how Dubai has already taken steps to address it, and that is one of the things that impresses me with this place, they make their mind up on where they want to go, and they go there.

"There is a massive drive now that they have gone from 13 to 10 in these statistics, which has shown them that the policy they put in place five years ago has paid off and by addressing new policies on research and innovation they can further climb the rankings."

Fuglerud's optimism is fueled by the fact that Dubai is a strategic location. It is well positioned for the emerging markets and there is huge growth potential for this region. "There are a lot of positive developments in Saudi and that is positively impacting UAE as well," he continues. "For all the emerging trade towards the East Coast of Africa this is a very good location to drive that from. For the maritime industry in general I think the future is bright.

"If you look at the government, they are moving very quickly. They seem to be moving quicker than other countries. But companies seem to be lagging a little bit behind, at least in the maritime industry, but the big players are developing quickly and investing heavily to position themselves."

#### Living in a Free Zone

One of the big success stories in the



Photo: DP World

## One of the big success stories in the emirate is DP World and its Jebel Ali Port and associated free zone.

emirate is DP World and its Jebel Ali Port and associated free zone. The port itself is the 10 largest container port in the world. Its 102 ship to shore (STS) cranes handled 14.7m TEU in 2016 from 11,000 vessels. The facility has three terminals. Terminal one and two are older facilities that are about to undergo upgrades to increase automation, while terminal three is already fully automated. Terminal four is under construction and will be brought on line as market demand increases. That expansion will bring total handling capacity to 22.1m TEU by the end of this year.

The huge Jebel Ali Free Zone (Jafza) is home to more than 7,300 international companies, while the port has tremendous capabilities to process and deliver cargo. Jebel Ali's gate automation system and paperless processing of cargo documentation are among the most modern technology-driven facilities in the world.

"Jebel Ali is our flagship port and has been recognized as the best seaport in the Middle East for over two decades reinforcing our role as a leading enabler of world trade," Sultan Ahmed Bin Sulayem, DP World Group Chairman and CEO, says. "The reputation of Jebel Ali has been built over time on our operational efficiencies, through the work of our employees and our customers, and without whose support this achievement would not have been possible.

### Goltens goes Green

Sometimes, a vessel in port needs more than just a berth to discharge or load cargo. Fortunately, the Dubai branch of global independent repair specialist Goltens operates a 10,000 square meter facility within the Dubai Maritime City (DMC) that is capable of docking vessels up to 6000 DWT, 125M LOA. The Dubai hub is a key location in their global network that enables shipowners to minimize asset downtime with diesel

services, in-situ machining, and BWT system retrofits. They have, for over 70 years, been the alternative when the original equipment manufacturer is unable to meet the budget or the time frame available. One area that they are looking to for growth is environmental services, a division that is led by manager of Green Technology Solutions, Matthew Plumtree.

Goltens have been involved in supplying green services since 2010 with the same ethos that they have from a repair point of view: reducing downtime and minimizing the cost to the customer. "The critical legislation we have now is ballast water management (BWM) and the Sulphur Cap," Plumtree explains. "We have been talking about it for eight years and it keeps going backwards and backwards, and the sulphur cap which comes into effect in 2020. The difference between the two is that with BWM you have lead time based on IMO rulings whereas sulphur emissions is a drop dead date of 1st January 2020. After that date you must either use low sulphur fuels or have a means to clean exhaust gases to meet requirements.

"There is a tacit acceptance of BWM, although there is still a resistance to it from the shipowners. We have seen the number of 3D scans double last year compared to 2016, but many companies are still planning on leaving it until the last minute. One contract we signed in 2016 for 10 vessels has been postponed several times and they will probably pick

it up again in 2023 to carry out the installation. We have scanned the vessels, carried out conceptual design but it has been on hold until the last minute."

Plumtree says that shipowners are still hoping that they will be able to avoid the installation. "While there is this general acceptance, shipowners are still thinking that at some point there may be a change in the regulations and vessels of a certain age may be exempted. The problem with BWM is that the technology has still not been proven; it's out there and installed on many vessels now but is still an unknown factor about how it operates. There is no return on investment for a BWM system, it is purely a cost. You can't charge more because you have a BWM system because it will be a requirement."

### Managing the Market

When it comes to shipping services, being able to handle an account anywhere in the world is a great asset. With 300 offices in 70 countries Inchcape Shipping Services are in prime position with that regard.

Their office in Dubai handles the two key ports in Dubai and is the pivot for their Middle East operations. It's just more reason that Dubai is rising to meet the global logistics challenge.

One of three global maritime service suppliers – along with Ulstein Ship Services and Gulf Agency Company – together they capture 15 percent of the global market – each with five percent.

However, their tightest competitors are not the other two global companies but the local companies who are often stronger and more flexible. In the Middle East region that is Kanoo Shipping and Sharaf.

"The whole sector is now more cost aware and conscious of credit terms, so we are not seeing the same sort of prices that were there before," Daniel Vikstrom, Vice President Marine Services Middle East at Inchcape explains. "It is no longer based on service levels and personal relationships, but purely on price with many companies. As an example, the average charge for a tanker call into Dubai is now \$500 down from around \$2,400 before the oil price dropped."

One of the major challenges established agents face is that there are no barriers to entry into this industry. "If I wanted to I could resign my position, get in my car and drive to Fujairah and apply for a license and set up as an agent with very little overheads," Vikstrom adds. "There are more and more smaller companies emerging that will not be able to cope in the long run. The trend will be that there will be some consolidation with the big three probably ending up with around 15 percent of the market each."

### Local Port, Global Reach

With a seat at the grownups table at IMO, and world class facilities packaged in a high tech service package, the Dubai Maritime Cluster is determined to further develop an already impressive regional logistics hub, into one of the world's top shipping destinations. Leveraging global vendors, solid local infrastructure and regional relationships, they are well on their way to ding just that. The Dubai Maritime Vision 2030 initiative, launched just four years ago, is already yielding fruit. The next 12 years therefore promise to be even more exciting.

## Carnival to Build Dubai Cruise Terminal

Carnival Corp. signed a partnership agreement with Meraas to develop the Dubai Cruise Terminal to open in October 2020. Under the agreement, signed by His Excellency Abdulla Al Habbai, Group Chairman of Meraas, and Arnold W. Donald, CEO of Carnival Corp., the companies will collaborate across port development, terminal management and new cruise development opportunities at Dubai Harbor and the broader region. Dubai is set to become central to Carnival Corp's operations in the region.



# cruising china

**While China has steadily built shipbuilding market share, cruise ship construction – more specifically mastering the logistical complexities inherent in cruise ship design, outfit and construction – has proved elusive. But it appears that Chinese shipbuilders have turned the corner, with contracts signed for the first cruise newbuilds. We were in Tianjin, China, earlier this year for the 4th Annual China Maritime Finance Forum for a look behind the covers of passenger vessel in China, present and future.**

**BY GREG TRAUTHWEIN**

“Here in China we saw an unbelievable opportunity, as it is a country that has the intention, the interest and the resources to develop its market for passenger vessels,” said Carlos H. Reyes, Tillberg & Reyes Group Co., Ltd. “The largest cruise lines are expanding in Asia, and there is a need for cruise ship building, ship repair and refurbishment in China.” Reyes is a partner with Tomas Tillberg in one of the world’s foremost design houses serving the global cruise market, but the organization’s endeavors span far beyond design, as it operates a subsidiary based in Shanghai, China, which is can help guide cruise vessel owners from start to finish, with insight and experience in tapping the emerging Chinese maritime finance market to hands-on contact and full project management with the yard to ensure that the hotel operations and interior outfit are completed to world class standard. “First and foremost, from the owner’s perspective, is proving that the production is

world class (in China),” a process that, in Reyes’ estimation, is neither short nor straight.

“We started coming to China to understand the market, we started visiting and establishing relationships with the shipyards, understanding their plans for the future for passenger vessel construction. They have a clear vision for the passenger vessel market – they understand the increasing (cruise demand) in China, as Chinese have developed a ‘taste’ for cruising which didn’t exist here before.”

He said Chinese shipyards are fully capable of building the hull and machinery, but as the cruise design and build is a highly sophisticated and integrated process, honed for more than three decades at the leading cruise ship building shipyards in Europe, support is needed from the outset to ensure that all aspects of the hotel portion of the program are designed, manufactured, installed and tested correctly. He said

**China Cruise Pioneer: Niels Erik-Lund’s Sun-Stone Ships cut steel on its first new Infinity-class vessel to be built at China Merchant Heavy Industries. While the ships are being built in China, the project – which could eventually total 10 ships – is a global collaboration.** “We believe this is the perfect marriage of European cruising expertise with efficient and capable production in China. Our Norwegian technical design, and our Finnish interior design will be brought to life by the oldest, most respected ship builder in China.” **This is the first cruise ship built in China for the international cruise market.**



Greg Trauthwein



**“Here in China we saw an unbelievable opportunity; it is a country that has the intention, the interest and the resources to develop its market for passenger vessels. The largest cruise lines are expanding in Asia, and there is a need for cruise ship building, ship repair and refurbishment in China.” – Carlos H. Reyes, Tillberg & Reyes Group Co., Ltd.**

Chinese shipbuilders recognize the need to acquire the experience, and are investing to do so. Reyes cited five keys for success in building cruise ships in China:

- Adequate facilities to build a specific ship.
- Engineering capabilities to design and fulfill to an owner's guidelines and regulation.
- Expert architecture and design for all hotel aspects of the ship.
- Experienced project management and seamless communication with the owner, shipyard, designers and suppliers.
- Experienced interior outfitters.

Reyes and his team were involved in two of the first cruise ship construction contracts in China: the frame contract to build 10 expedition vessels for Sunstone at China Merchants Heavy Industry; and the contract for a 218-m, 63,000-grt, 2,800-passenger RoRo ferry at Xiamen Shipbuilding Industry Co., Ltd.

“We signed the first project with SunStone, which is a framework agreement for 10 ships to be built at China Merchant Heavy Industries in Haimen, China. China Merchants was very supportive, doing all that they could to make the project happen,” said Reyes. Tillberg & Reyes Group Co., Ltd. were the brokers for the project, and it also helped in developing the financial structure. “The owner is a very experienced owner in the expedition vessel segment, so they knew exactly what they wanted. We needed

to have engineering from Europe which relates to the engineering relative to a passenger vessel,” something they do not have at a Chinese shipyard ... yet, said Reyes.

### Show me the money

While bringing together the requisite engineering and hotel outfitting talent was necessary, in China Tillberg & Reyes Group Co., Ltd. aims to be a one-stop-shop with finance assistance, too.

“The finance channels in China were not geared for cruise ships – they have not done cruise ship (finance deals),” said Reyes. “So as we started talking to many different groups for the SunStone project, and for another possible project that we have right now, we realized how difficult (it is) in the finance: difficulties that have been clearly identified,” during the 4th Annual China Maritime Finance Forum.

To fill the gap Tillberg-Reyes Leasing Company was formed, a leasing company specializing in financing passenger vessel projects. “I like to think of ourselves as we are ‘integrators’ of highly experienced resources that work very well together, that make possible the construction of passenger vessels. So we integrate the brokers part of it, we integrate with the finance part of it, we bring the engineering that is necessary to the project, we integrate the outfitters that are necessary to the project, we integrate our own designs and project management. So it's an integration of expert

resources that make this possible.”

Another point made crystal clear at the Tianjin Summit was China's plan to intensify penetration into global ship finance, filling a void left when traditional lenders in Europe tightened access to capital in the wake of the global financial recession. Finance leaders reiterated throughout the summit the lack of expertise in the field and the desire to gain intelligence, experience and share of market.

“Something I find interesting is that usually, when you are talking to a top leader, they would never tell you what they don't know,” said Reyes. In China he has found the opposite. “I have found here that when you are talking to the highest level and most expert person in whatever field, they have no problem telling you, ‘I don't know or we don't know.’ That's great because it opens a door for cooperation.”

### Understanding the Chinese Cruise Passenger

While cruise vessel construction in China is starting for international markets, catering to the tremendously large potential home market will be key to fueling future growth.

According to Hu Xiang, Chairman of Tianjin Xingang Shipbuilding Heavy Industry Co., Ltd., cruise vessels built for the Chinese market must have characteristics – including décor, food, shopping and gambling facilities – that are appealing to the China market. He took part

in a signing ceremony during the 4th Annual China Maritime Finance Forum to develop, design and build an 80,000-ton passenger ship in his Tianjin, China shipyard that will be intent on delivering to that specification.

According to Reyes, it is simply not practical or cost effective to take an existing ship designed and built for the Caribbean market and to turn it into something that is broadly appealing to the Chinese cruise consumer. To do so would mean completely reconfiguring the ship, adding volumes to the shopping and casino spaces.

“How do I change that in a ship?,” Reyes asks rhetorically. “The space and power is already allocated; it's very difficult to double or triple the size of the casino; the cost would be astronomical. As much as we can adjust an existing vessel and make it as comfortable as possible for the Chinese market, there are fundamental things in the design that we just cannot change.”

So the best option is designing and building from the ground up catered to the Chinese cruise consumer needs and tastes.

“They spend money, they go shopping. The way the cabins are designed, the size, the colors they like, the textures they like, the feeling inside the cabin. You can redecorate the cabin, but it doesn't do much. So for that reason, many investment groups have recognized that they should build a ship for the Chinese market.”

# SunStone's Groundbreaking Deal

A steel-cutting ceremony was held for SunStone Ships, Inc.'s first new Infinity-class expedition cruise ship, and at the same time a shipbuilding contract was signed with China Merchant Heavy Industries (CMHI) for the series' second vessel, Infinity II (tbr), scheduled for delivery in August 2020. "While we aren't yet ready to announce the long-term charterer of the second vessel, we are happy to report that long-term charter contracts have already been signed for the Infinity III and Infinity IV," said SunStone's President & CEO, Niels-Erik Lund.

So far, shipbuilding orders have been confirmed for the first three Infinity-

class vessels. The series is expected to reach up to 10 ships in total.

The new Infinity-class cruise ships are the first to feature European design, technology and oversight to be built in a Chinese shipyard. "We believe this is the perfect marriage of European cruising expertise with efficient and capable production in China," said Lund. "Our Norwegian technical design, and our Finnish interior design will be brought to life by the oldest, most respected shipbuilder in China. Take into account delivery of our first vessel to an Australian customer, and we have a well-rounded global team making this dream a reality."

The steel-cutting ceremony for the

first SunStone newbuild at CMHI is significant as the vessel is not only the first cruise ship being built at the yard, but it is actually the first cruise ship being built in China for the international market.

This first ship will be on a long-term time charter to Aurora Cruises, Australia, who have named the vessel Greg Mortimer, after the respected explorer and founder of Aurora Cruises.

"The new vessels have quite a number of features not existing on the current expedition fleet," said Lund. "First, the design is primarily focused on safety, comfort and green operation. From a safety point of view, Infinity has Safe Return to Port, Polar Code 6, Ice Class 1A, and

fulfill all the newest SOLAS regulations as well as all known SOLAS regulations coming into effect in the future. From a comfort point of view, the vessels have zero speed stabilizers, X-bow and dynamic positioning, and is an all-balcony suite ship, with much more public space per passenger than most of the existing expedition fleet."

The vessels will be equipped with a diesel/electric system with Tier III engines, operating on marine gas oil. "In our opinion, based on the very remote areas of operation, as well as the need for long-range, from a practical point of view, there are no alternatives than the best possible diesel engines," said Lund.



## Greg Mortimer Main Particulars

Type	Exploration Passenger Ship	MGO (ISO F-DMX)	560 m3
Port of Registry	Nassau, Bahamas	Lube Oil	30 m3
I.M.O. No.	9834648	Fresh Water	160 m3
Keel Laid	June 2018	Ballast Water	100 m3
Hull Number	CMHI 196-1	Main engines	Wärtsila Finland OY 2 x Wärtsila 6L26, 1,200 kW 2 x Wärtsila 8L26, 1,600 kW
Shipyard	China Merchants Heavy Industries	Generator	Cummins
Design	Ulstein Design & Solutions	Side thrusters	Brunvoll AS
Max. Number of Persons on Board:	275	Propulsion motors	Brunvoll AS
Passenger	160+20 (Sofa Bed)/180 Beds	Speed Stabilizers	Rolls Royce Aquarius
Crew	95 Crew Beds	100/8.1 sq. m. Swept Folding/Stabilization@	Rest
Classification	Bureau Veritas	Ship's voltages	690V/ 400V/ 230VAC-24V DC
Length, o.a.	104.4m	AC	Aeron A/S, Norway
Breadth (Molded)	18.4m	Propellers	Brunvoll AS
Draft (Scantling)	5.3m	Heat/Demister	Aeron A/S
Draft, design	5.1m	(Special Equipment for Polar Regions Ops)	
Gross Tonnage	7400	Fire Detection	Consilium AB
Speed, max.	15.5 knots	FiFi System	Danfoss-Semco A/S
Endurance/Range:	11,200 NM	Elevators	Almak Hek AB
Full Operation Consumption per 24 hours:		GMDSS	Sailor
9.1 Metric Tons. (2,000 kW)		DPS	Kongsberg K-Pos
In Port or Idle Consumption per 24 hours: 2.7		Mooring/Anchoring	Adria Winch, Croatia
Metric Tons. (600 kW)		Coating	Jotun Marine Coatings
Transfer Voyage: Consumption per 24 hours:		BWMS	Alfa Laval Pure Ballast
6.9 Metric Tons. (1,500 kW)			
Lube Oil Consumption per 24 hours:			
40-45 Liters			
Life Boats & Davits	Neptune Marine		
Life Rafts:	Viking		

**OmniTHRUSTER™**  
Marine Maneuvering and Propulsion Systems

## UNCOMPROMISED CONTROL



**HT Series**

- Low Submergence Requirement
- Small Hull Penetrations
- Auxiliary Propulsion/ "Take Home" Capability
- Effective Thrust in Currents
- Proudly Made in the USA!

**JT Series**

**Waterjet Bow/Stern Thrusters**  
Up to 2,200HP

**2201 Pinnacle Parkway • Twinsburg, OH 44087**  
**(330) 963-6310    www.omnithruster.com**

# Zero Emission Ships: Are Biofuels Next

**Table 1:**

**Representative ships being used in the scope of this study**

**Bulk carrier**

53,594 dwt  
Main engine Power 8,958 kW  
Design speed 14 knots

**Containership**

8,893 TEU  
Main engine Power 67,879 kW  
Design speed 25 knots

**Tanker**

109,678 dwt  
Main engine Power 14,008 kW  
Design speed 15 knots

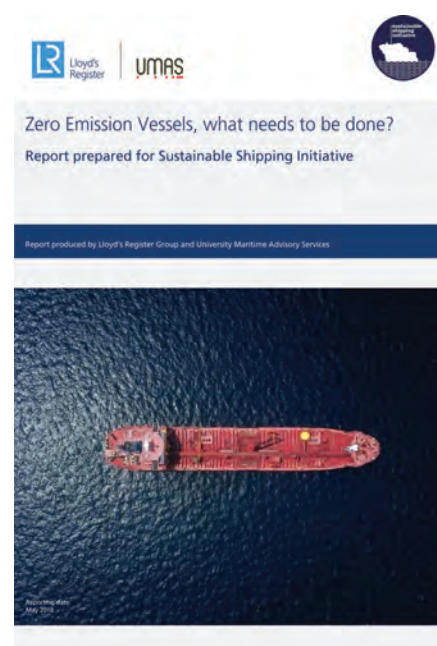
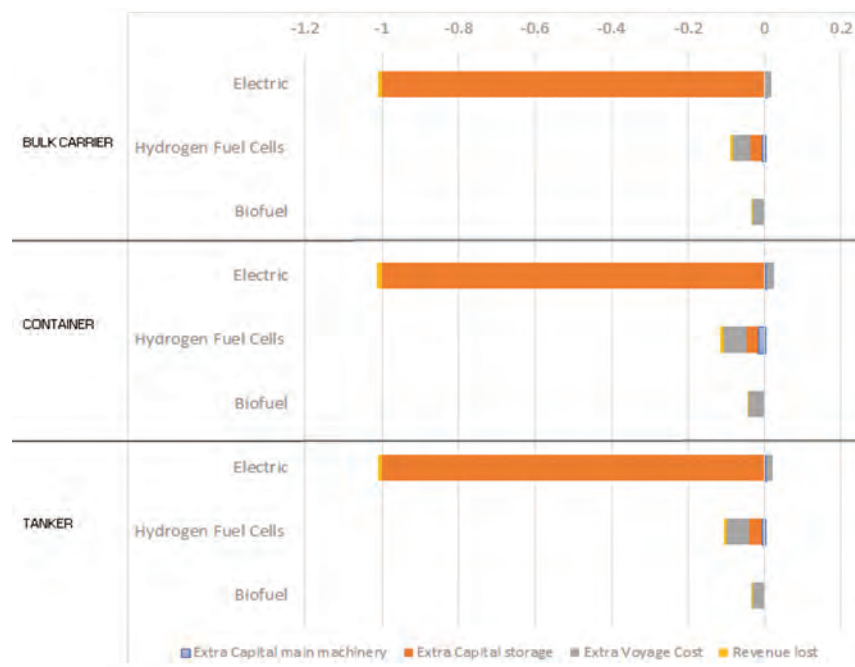

**As the global shipping industry collectively wrestles with poor financial returns gratis of a historical and extended market downturn, it is simultaneously mandated to install step changes in onboard technology, with the target being the 'zero emission vessel.'**

A recent report authored by Lloyd's Register and University Maritime Advisory Services (UMAS) says that biofuels currently present the most affordable option for shipping, though great challenges remain in relation to the scale of production and sustainability of biofuels. The report was geared to mainly deep-sea oceangoing trades including containerships, bulk carriers and tankers. (See Table 1)

"The report makes clear that the tech-

nology is with us today, but investment is needed both to bring the technology to scale and to encourage a wider take-up," said Stephanie Draper, Chief Change Officer for Forum for the Future and co-chair of the Sustainable Shipping Initiative (SSI). "The shipping industry will need multiple solutions, and investment for different technologies – not just biofuels – to reach beyond fuel efficiency to decarbonization."

The report also examines electric power and hydrogen fuel cells, and takes note of the upstream CO<sub>2</sub> emissions which need to be resolved as these fuels will have to be judged on an environmental performance from "well to wake," and not just on emissions from ships. As shipping is now in concert with the Paris Agreement, the benefits of other land-based technologies and

energy production should help to drive down upstream emissions for ships fuel.

As always, in any industry, cost will be a driver. The profitability results can be understood by considering what components outweigh others. For the electric ships, the normalized cost is dominated by the additional capital cost of storage – batteries. The electric vessel does have a positive contribution in the form of voyage costs – this comes from the fact that under this scenario, projected costs of electricity are cheaper than the HFO alternative, however, this positive does not compensate for the much larger associated cost of the batteries.

For hydrogen fuel cells, the contributions to the cost from all four measured components are noticeable, with the voyage costs coming from the hydrogen fuel cost, being the largest component.

Biofuels have no associated additional capital costs for machinery or storage when compared to the reference ship, given that biofuels can be stored and combusted in machinery with identical costs of conventional HFO engines.

As a result of this report, the SSI engaged in a deep-dive into biofuels in 2018 to assess the viability of biofuels for the world fleet.

"Biofuels represent a stepping stone to further emissions reduction," said Tom Holmer, General Manager of the SSI. "Alternative marine fuels provide a huge opportunity for creating value and finding sustainable solutions. The SSI will continue to look at the whole value chain and this report highlights that the next 10 years will see huge changes in the way ships are fuelled."

## Cummins QSK95 Propulsion for Ferry Newbuild

Azam Marine's next newbuild, Kilimanjaro VII, will be the first passenger ferry powered by QSK95 propulsion engines from engine manufacturer Cummins. Two QSK95 propulsion engines will provide main propulsion power to the new Incat Crowther designed fast catamaran, which will be built by Australia's Richardson Devine Marine in Tasmania. Cummins said the QSK95 offers a power output previously exclusive to medium-speed marine engines with power ratings from 3,200 hp to 4,200 hp for propulsion, auxiliary, generator and diesel electric applications. Azam Marine and Coastal Fast Ferries operate passenger ferries between the islands of Zanzibar, Pemba and mainland Tanzania. The 45-meter Kilimanjaro VII will be the largest of the seven vessels in the fleet.





## ABB Helps Support World's Largest Windfarm

As the marine industry increasingly moves toward hybrid and electrical power, companies like ABB are leading the way. ABB's tech allowing integration of batteries received a vote of confidence as Louis Dreyfus Armateurs (LDA) ordered its second wind farm service vessel featuring a broad swath of ABB's solutions.

LDA will add a second 83-m wind-farm service operation vessel (SOV) to its fleet, with ABB tech onboard with its power distribution system Onboard DC Grid at its core. The vessel will support operations at Hornsea Project Two off the UK coast, which, upon completion in 2022, will become the world's biggest wind farm capable of powering over 1.3 million homes.

In addition to Onboard DC Grid, the ABB scope of supply includes tunnel thrusters, generators, transformers, batteries, ABB Ability Marine Advisory System – OCTOPUS and ABB's Remote Diagnostics Services. ABB will also provide its Power and Energy Management System (PEMS), which allows battery power to act as backup for running generators, again cutting the need to run spare capacity, and reducing maintenance and fuel consumption in the long-term.

## The Switch Passes FAT Test

The Switch Norway, part of Yaskawa Corporation's Yaskawa Environmental Energy Division, reports it has completed a Factory Acceptance Test (FAT) for its Electronic Bus Link breaker (EBL). It is the first time the new EBL, a key ele-



ment within its DC-Hub, has undergone a FAT. The procedure was conducted in Trondheim under the supervision of DNV-GL and the undisclosed end customers. There were no issues recorded with the first three EBL units to undergo stringent testing, with a further three to

undertake the same process prior to delivery on an advanced offshore vessel.

"We only received the original order in September last year, so it's been a tight turnaround," said Asbjørn Halsebakke, General Manager, The Switch Norway.

"The next step will see full load test-

ing onboard the vessel with the EBL working to enable our simple, reliable, robust and very cost-effective DC-Hub solution. We see this as the future of sustainable maritime operations, so it's very satisfying to observe the products making headway in the market."



**45 Years of Experience In Humidity Control**

**- Rusting & Corrosion -**  
**Prevention Is Better Than Repair !**

**Refrigerant & Adsorption Models**  
**Capacities From 17 ppd to 3,173 ppd**



**Refurbishing, Mothballing or General Environmental Control - EIP Have The Solutions.**

**Experts In Humidity Management !**

**Ebac Industrial Products Inc**



**East Coast Office**  
700 Thimble Shoals Blvd, Suite 109,  
Newport News, VA 23606-2575

**West Coast Office**  
2060 Chicago Ave, Suite C7,  
Riverside, CA 92507

**Toll Free 1-855-873-6800    www.ebacusa.com**



**DCL**  
DREYFUS • CORTNEY • LOWERY  
MOORING • RIGGING

**STOCK (Purchase and Rental):**

- Anchors (All Types)
- Anchor Chain and Fittings (New and Used) Grades 2, 3, R4 and R5
- Marine Fenders (Pneumatic and Foam Filled)
- Smit Towing Brackets, Tow Plates, Towing Shackles, Towing Chains and Towing Wires
- LBNO Towing Shackles (Oval Pin), Anchor Line Hooks, "Pee Wee" Sockets, Hawser Thimbles (MADE IN THE USA)
- Heavy Lift Slings, Lift Design and Engineering Services



**www.dcl-usa.com**  
**Email: sales@dcl-usa.com**  
**Ph: 800-228-7660 • Fx: 504-947-8557**  
**Available 24/7/365**



**Business news you can trust and advertising results you can count on. We have you covered in every sector of the industry.**

The Maritime Media Network's diverse portfolio of publications includes: *Maritime Reporter & Engineering News*, *Marine News*, *Marine Technology Reporter* and *Maritime Logistics Professional*.

Reaching a total average circulation of 114,930, these four publications reach decision makers all over the maritime industry, are audited by BPA, and are only available in the Maritime Network.



# World First: LNG-Fueled Fishing Trawler

**MAN Diesel & Turbo was picked to provide a complete propulsion package and fuel-gas system for the world's first fishing vessel with LNG propulsion, an 86-m newbuild purse-seiner dubbed 'Libas' to be built by Cemre Shipyard in Istanbul.**

Libas will feature a MAN 6L51/60DF main engine, Renk gearbox, MAN Alpha propeller system and MAN Cryo LNG fuel-gas system with a 350 cu. m. tank. Liegruppen, the Norwegian fishing group, has ordered the vessel, while compatriot, Salt Ship Design, has provided the design.

"This is a pioneering project," said Wayne Jones, Chief Sales Officer, MAN Diesel & Turbo. "At MAN we are convinced that low-emission gas fuels are the silver bullet to decarbonizing the shipping industry."

Calling for a 'Maritime Energy Transition' MAN D&T considers the use of natural gases as the fuels of choice in global shipping as the most promising way to supporting the goal of a climate-neutral shipping industry. Launched in 2016 after COP 21, MAN's initiative has since found broad support within the shipping industry and politics.

In 2015 MAN Diesel & Turbo has purchased and fully integrated the fuel gas specialist Cryo AB. Under the brand MAN Cryo, the company has since then offered systems for the storage, distribution and handling of liquefied gases.

Fuel-gas system:

The scope of the MAN Cryo fuel-gas system covers:

- 350 cu. m. vacuum insulated cylindrical type C tank
- TCS/coldbox with process equip-



Salt Ship Design

ment, manifold and instrumentation

- emergency shut-down system
- bunker station for supply of LNG to tank.

The system is designed for a net tank volume of 330 cu. m. of LNG and tem-

peratures down to minus 163 °C. The tank stores LNG at the lowest possible temperature and pressure until it is evaporated and supplied to the dual-fuel MAN 6L51/60DF main engine, as consumption demands.

## Wärtsilä's Nav System and Operational Efficiency

**Wärtsilä is using its in-house capabilities to advance operational efficiency and safety on ships.**

The latest: a reportedly successful testing program onboard the cruise ship Carnival Costa Crociere's Costa Atlantica. The testing combined the use of Wärtsilä's Eniram Trim and Nacos Platinum systems, enabling the crew to have better understanding of the ship's trim, helping to enhance safety and efficiency.

Eniram Trim functionality is designed to allow immediate response to changing conditions and the maintaining of an optimum trim in real time. Combined with Wärtsilä's Nacos Platinum control system for navigation, automation and dynamic positioning, operators can yield significant operational benefits, including enhanced better visibility, fewer workstations and improved customer support in the collection and subsequent analyzing of data. The combining of the Eniram and Nacos technologies makes the system easier to use, and creates greater availability of the needed guidance information. This information is available on all the Nacos screens, thus providing greater visibility and awareness.

"This program fits well into Wärtsilä's digitalization strategy, our vision

for a smart marine future and our roadmap of horizontal integration across Wärtsilä's product portfolio," said Maik Stoevhase, Director Automation, Navigation, Communication, Wärtsilä Marine Solutions.

Eniram, a specialist company providing energy management technology to reduce fuel consumption and

emissions, was acquired by Wärtsilä in 2016 to be a catalyst in creating a digital and performance driven company.

The Wärtsilä NACOS Platinum system represents a unique combination of control systems for navigation, automation and dynamic positioning, as well as power and propulsion, integrated into a single system.

**The Nacos Platinum system's conning page showing also the Eniram Trim functionality.**



Wärtsilä





SF Marina

## Floating Pier: Flexibility for Donsö Harbor Project

SF Marina has built pontoons and floating breakwaters for a range of bespoke marinas designed to suit local conditions worldwide, from a fishing station in the north of Iceland to the sunny but continually storm-hit Caribbean. The company has leveraged this experience for the Donsö Harbor Association in a project called Donsö Djuphamn – the deep water harbor project.

“This project will benefit the fishing and commercial fleets, but it will also benefit other marine traffic such as official vessels. The main aim is to get our fishing vessels back home, which are over 50 meters in length and have a draft of 7 meters. And, of course, other commercial operators will also have the opportunity to land,” said Jonas Backman, Chair of the Donsö Harbor Association.

Here, the depth is 17 meters, which means that it is possible to accept vessels with a draft of 10–12 meters – as opposed to other islands in the area where the maximum limit is set at 6 meters.

“It is not just that it would be very difficult and costly to build a 10-m high pier at this location. There is a significant difference between a floating pontoon and a permanent pier as far as the impact on the environment is concerned,” said Michael Sigvardsson, CEO at SF Marina.

Floating pontoons of this size gain a protective breakwater effect, and spaces are created beneath the pontoons that provide the conditions for small fish and plants to thrive.

The main pontoons are 100 × 10 meters, i.e. 1000 sq. m., while the ‘gangplank pontoon’ is 25 meters in length. This provides 100 meters of pier on the outside, 95 meters on the inside and 35 and 10 meters, respectively, on the sidewalls – a total of 230 meters. Each 25

× 10 meter pontoon is 1.8 meters tall and weighs almost 200 metric tons, i.e. almost 800 metric tons for the main pontoons.

“The whole of this is anchored using an anchor weighing a total of 360 metric tons and 800 meters of 50 mm diameter cable. This means that you need to watch your step, both when doing the calculations and when performing the installation,” said Stig Jansson, Project Manager at SF Marina.

Everything has been manufactured at Wallhamn, Tjörn, which is the site of SF Marina’s production plant, and then transported in several parts to the Gothenburg archipelago. The installation was opened on May 18, with speeches from, among others, Ann-Sofie Hermansson, Chair of the Municipal Executive Board

in Gothenburg.

So far, Donsö’s new harbor has managed to find four regular customers, all fishing vessels with home ports in Denmark. The positive financial effects that will come once supplies, equipment, diesel and everything else are bought on-site will provide the conditions for Donsö to be alive all year round. More berthing also means that the Donsö shipping companies’ own tankers will be able to come home for viewing and maintenance, instead of being repaired in Denmark and other harbors. However, the 130 meter pontoon is just the beginning. The vision is for a further two times 130 meters of berthing so that a total of 600 meters can be offered, including both sides. This would allow significantly larger boats to be accepted.

[www.sfmarina.com](http://www.sfmarina.com)



Anchor

MARINE & INDUSTRIAL SUPPLY, INC.

REQUEST ONE OF OUR NEW CATALOGS  
[SALES@ANCHORMARINEHOUSTON.COM](mailto:SALES@ANCHORMARINEHOUSTON.COM)



AUTHORIZED YOKOHAMA FENDER DISTRIBUTOR

- New, Used and Rental Options Available
- New Harness Installation Or Harness Repair with Quick Turnaround
- Foam and Pneumatic Fenders Available

IN STOCK & READY TO SHIP

WORLDWIDE

24/7

LARGEST INVENTORY IN THE USA

NEW & USED

- Anchors
- Chains
- Fittings
- Towing

- Hardware
- Wire Rope
- Cordage
- Blocks

- Dock
- Fenders
- Buoys
- Spill Boom

(800) 233-8014 • [ANCHORMARINEHOUSTON.COM](http://ANCHORMARINEHOUSTON.COM)



Nolan



Weldon



Glas



Unda



Morganti



Boer

#### Obituary: John "Jack" J. Gallagher

John "Jack" J. Gallagher, a maritime industry veteran and founder of Gallagher Marine Systems, passed away at the age of 89. Jack's greatest professional passion was his work as a Spill Manager/Qualified Individual, a role in which had had few peers. Jack served as a P&I correspondent/maritime attorney, inventor and patent holder of oil spill mitigation technology, pioneer in the field of oil spill contingency planning, educator and founding Director of the Center for Marine Environmental Protection & Safety at the Massachusetts Maritime Academy.

#### Obituary: Hans Gerhard Kahn

Jumbo, the maritime heavy lift company, announced that its founding father, Hans Gerhard Kahn, passed away at the age of 95 (1922-2018). Kahn realized his dream of becoming a ship owner and became one of the first pioneers in the heavy lift shipping industry.

#### Weldon Named VP at HII Ingalls

Scott Weldon was promoted to vice president of supply chain management at HII's Ingalls Shipbuilding division.

#### Glas Joins Bouchard Transportation

Bouchard Transportation Co., Inc. said that Captain Robert "Bob" Glas has joined the company as Vice President of Vessel Compliance and Auditing.

#### Unda Named CEO of SENER Group

Jorge Unda, until now the Managing Director of the Engineering and Construction area of the SENER Group, has been appointed CEO for the entire Group, replacing Jorge Sendagorta, who previously combined the positions of President and CEO.

#### New Tanker JV

A new ship holding company has been formed through a joint venture agreement between Gunvor Group, ship management company Oceangold Tankers

and investor Maas Capital. The three partners hold an equal share in the new company, ClearOcean Tankers, incorporated in Cyprus. The JV entered into shipbuilding contracts for six vessels from South Korean shipyards, all scheduled to be delivered during the first half of 2019.

#### Nolan Tapped as TOTE CEO

Tim Nolan has been named the next president and CEO of TOTE Inc. He was president of TOTE Puerto Rico.

#### Morganti Joins Ecochlor

Ecochlor, Inc. said that John Morganti has joined the company in the new position of Vice President of Sales and Marketing.

#### Guthrie to Direct KVH in Asia-Pacific

KVH Industries, Inc., said that Mark Guthrie has been named KVH's vice president for the Asia-Pacific region.

#### Damen's Boer Takes Lead at WISTA

Damen's Head of Communications, Sylvia Boer, has recently been appointed President of the Netherlands chapter of WISTA – the Women's International Shipping and Trading Association. WISTA the Netherlands was founded in 2000 and currently has 140 members from across the maritime industry.

#### Evac to Acquire Cathelco

Evac will acquire Cathelco, a manufacturer of equipment for ships and offshore installations, a synergistic move for Evac as Cathelco customers include Evac's current marine and offshore customer groups, including ship owners, shipyards, fleet managers, rig owners and operators, oil companies, navies, and designers.

#### GONDAN Wins Trawler Contract

GONDAN's most recent contract is for an advanced stern trawler for Prestfjord AS, one of Norway's most important fishery and fish farms owners. This vessel, designed by Rolls Royce Marine

- in charge also of supplying the main equipment - will measure 77.3 x 17 m, and be built in steel with aluminum superstructure. When completed it will operate in Arctic areas, in the Barents Sea and Svalbard waters.

#### Silversea Orders Ship at Fincantieri

Monaco based cruise line Silversea Cruises has ordered another new ship from Italian shipbuilder Fincantieri, with delivery scheduled for the fourth quarter of 2021. The \$382 million contract for the construction of luxury cruise ship Silver Dawn follows Silversea's September 2017 order for sister-ship Silver Moon to be delivered from Fincantieri in 2020.

#### Bahri Chooses Digital Partner

Bahri Group, the largest owner of very large crude carriers (VLCC) in the world, has opted for digital solutions from Singapore based MariApps Marine Solutions to help meet its ship management software requirements.

#### R.W. Fernstrum Achieves ISO 9001:2015 Certification

R.W. Fernstrum & Company, a manufacturer in marine heat exchangers, received ISO 9001:2015 certification following an audit performed by Verisys Registrars in May. The scope of Fernstrum's registration includes the engineering, design, manufacturing, and sales of heat exchangers for marine and industrial applications.

#### ABS Bags CCG Contract

The Canadian Coast Guard has awarded a contract to ABS to provide classification and certification services for an existing fleet of 114 vessels and future vessel acquisitions.

#### Seaspan Recognized

Seaspan was recognized as a recipient of the Blue Circle Award at an Awards Ceremony in Vancouver, presented by the Vancouver Fraser Port Authority (VFPA). The award recognizes marine

carriers that excel in environmental stewardship and attain the highest participation rates in the Vancouver Port Authority's EcoAction Program.

#### EcoChlor: 36 Ship BWMS Deal

Ecochlor, Inc. won a contract to retrofit 36 vessels, including Suezmaxes, Aframax, VLCCs, Minicapes and Capes for Angelicoussis Shipping Group Limited (ASGL) with its ballast water management systems. Installations are expected to take place between 2018 and 2020 in Singapore, Dubai, Qatar and China.

#### Bomin: Fuel Lead

Germany-based Bomin Group has started delivering ultra-low sulphur fuel oil (ULSFO) as a marine fuel to ships calling in the Amsterdam-Rotterdam-Antwerp region, the company said. The ULSFO marine fuel has a maximum 0.1 sulphur content and complies with regulations on designated Emissions Control Areas (ECA) as well as the International Maritime Organization's (IMO) global sulphur cap in 2020.

#### Meyer Turku Turns Profit

Meyer Turku has made a third profitable year in a row with a net profit for the year of \$38m in 2017. This profit is used to finance the \$237m investment program of Turku shipyard. The revenue of the Meyer Turku Oy was \$959m in 2017 compared to 2016's \$935m. Net profit for the financial year rose from \$31.1m (3.3% of revenue) to \$38m (4% of revenue).

#### Rolls-Royce, Siem Agreement

Rolls-Royce signed a service agreement with Siem Offshore for the maintenance of its deck machinery installations aboard 12 anchor handling vessels. The five-year Maintenance Inspection Program (MIP) follows the delivery of 10 AHTS vessels in 2010, and two more that Siem took over ship management of in 2017.

# 2018 GREAT SHIPS

Every year, *Maritime Reporter & Engineering News* awards the most outstanding ships built around the world, recognizing Shipbuilders, Ship Owners and Ship Designers as leaders in their field. This edition — the much anticipated end-of-the-year Awards Edition — generates much excitement, as your work is profiled and delivered to the largest audited b2b maritime industry worldwide.



**MARITIME  
REPORTER  
AND  
ENGINEERING NEWS**

# ENTER YOUR SHIP TODAY

<https://greatships.shipbuilding.com>

The only way to have your ship featured in the December 2018 *Maritime Reporter & Engineering News*' annual Great Ships Edition is to complete the form online!

**DEADLINE:  
NOVEMBER 1, 2018**

# SAFETY ONBOARD & FIGHTING FIRE

Edited By Tom Mulligan, Science & Technology Editor

**F**ire at sea is arguably the most dangerous situation for any vessel and crew. This month Maritime Reporter & Engineering News explores latest technology developments to mitigate the risk of fire, from fire prevention to fire fighting to new fireboat design and deployment.

---

Sealing Valley is a new concept that has been developed by Hans Beele (pictured), President of Dutch engineering specialist Beele Engineering. Beele invested in, and opened last year, a center of expertise for the advancement of fire protection and watertight sealing technology to provide the highest possible levels of safety.

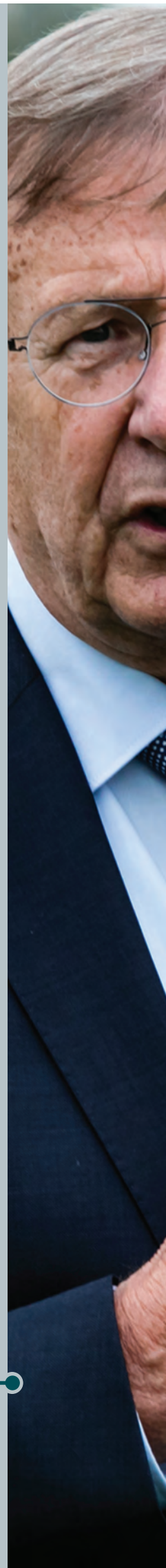



## Demonstration Fire & Rescue Boat

Designed and manufactured for firefighting and rescue applications, a new fireboat will be used to showcase the capabilities and craftsmanship of Silver Ships and its suppliers, whose parts and components enhance the mission-ready abilities of the new vessel. Silver Ships said it had tried to put as many capabilities as possible into this AM800 fire boat, its best-selling boat model.

The vessel is equipped with a center console EMT station and Darley fire pump, and is outfitted for missions that include dewatering sinking boats, fighting fires, providing medical treatment, search & rescue operations, and evacuations. The demo boat features a Wing Inflatables collar and twin 250 HP Evinrude outboards that allow the vessel to reach speeds of more than 50 knots.

Electronic systems installed by Raymarine provide the necessary navigation technology, while safety accessories such as FELL Marine's remote kill switch and Life Cell Marine Safety's throwable personal flotation device and ditch combo kit help protect passengers and crew during missions. Seats from Ullman Dynamics and boat matting supplied by Viconic Defense protect operators from injuries caused by impacts at sea.

The new fireboat has a 26-foot 7.92 meter long hull, an overall length of 32 feet, 8 inches 9.96 meters and an overall width of 9 feet, 7 inches 2.92 meters.

The demo boat will travel throughout the year with the Silver Ships team on a JDCI/Boatmaster trailer, making multiple stops at trade shows for vessel tours and test drives, and will be on show at the SEAFAC Annual Leadership Conference in Montgomery, Alabama from June 25-29 this year.

[www.silverships.com](http://www.silverships.com)



Silver Ships



Fireboy-Xintex

pletely from marine-grade 316 stainless steel. The Slimline Fire Damper is available in 56 standard off-the-shelf sizes up to 46.75 inches square 300 sq cm in order to accommodate a vessel's ductwork or to mate up to a particular size of rough opening. This gives extremely fast turnaround times for prompt delivery to builders and refit yards globally and the turnkey fire damper is ready to install on board a vessel on delivery. Each damper comes with a CE-approved fail-safe electric actuator 24-240 VAC or 24-125 VDC, as well as an integrated electro-thermal tripping device and test switch. These come completely wired up on a separate bracket and are ready for installation and power. Other features of the new fire damper include an extremely durable design, a patented locking mechanism that only engages during a fire event, a resettable thermal tripping device, dry contact outputs for open/close readouts, and a full A-60 class rating for use in either bulkhead or overhead applications.

[www.deltatsystems.com](http://www.deltatsystems.com)

## Vid System for Safe Tank Inspection

Zistos Corporation has launched its new Zistos 40X Tank & Hold Inspection System designed to perform a safe visual inspection of the interior of a large tank or hold in a vessel for hygienic conditions, foreign objects, cracks and corrosion.

To perform an inspection, this specially configured video pole camera system is inserted into a hatch and horizontal stabilizer rods span the hatch area, allowing the pole camera to stay situated without the need for the operator to support its position. The system allows all areas of the tanker interior to be visually assessed for problems without an inspector having to enter a confined space.

The system utilizes a self-illuminating, high-powered 40X zoom camera positioned on the end of a telescoping pole that can rotate through 360°. Images are viewed on a 5.6" LCD display with built-in DVR that can record video or still images for documentation.

Further information: [www.zistos.com](http://www.zistos.com)



Zistos

## 3M Novec 1230 Fire Protection

Fire suppression systems for use in marine applications are based on a range of chemical agents that includes carbon dioxide, HFC-227ea FM-200TM and 3MTM NovecTM 1230 Fire Protection Fluid. HFC-227ea and 3M Novec 1230 are clean agents that are safe to use in occupied spaces, and fire detection and suppression systems supplier Fireboy-Xintex is now offering pre-engineered automatic and manual clean-agent fixed-suppression systems based on both HFC-227ea and 3M Novec 1230 at up to 4,000 cubic feet approx. 115 cubic meters and engineered systems up to 17,500 cubic feet approx. 495 cubic meters.

3M Novec 1230 is the 'agent of the future' and will eventually replace HFC-227ea as it has little environmental impact and, at the right concentrations, is as effective as HFC-227ea in extinguishing fires. Further benefits of 3M Novec 1230 are that it is a clean agent with very low global warming potential GWP <1; it has low toxicity when used in a properly designed system, with no harm to personnel; it will not damage sensitive equipment in any way; it is not targeted for emission reduction or phase-out; and it comes with a 3MTM Blue SkyTM warranty that guarantees 20 years of environmental regulatory compliance.

[www.fireboy-xintex.com](http://www.fireboy-xintex.com)

## Fire Damper

Delta T Systems has introduced its new A-60 rated Slimline Fire Damper, which has been designed specifically to meet the needs of modern boat builders. This patented and USCG/MED approved damper is the narrowest on the market at only 4.25 inches 108 mm deep and is made com-



Delta T

ONS 20  
18

VISIT  
ONS.NO  
BOOK  
TICKETS NOW

Be there when the energy  
industry meet in Stavanger.

Four days of insight,  
networking and innovation.

Visit [ons.no](https://ons.no) to book your exhibition and conference tickets now.

Main theme ONS 2018

INNOVATE

ONS 20  
18  
EXHIBITION  
CONFERENCE  
FESTIVAL  
27 – 30 AUGUST  
STAVANGER – NORWAY

## SOLAS-compliant Insulation Solutions

The Tmax-Retrofit marine engine insulation system from Thermamax, a durable all-round solution for the insulation of older marine engines, has been designed to set new standards for safety and efficiency for both older and newer vessels: guaranteeing safety on board vessels was made top priority when designing the system, as compliance with safety regulations is an absolute essential regardless of the age of the engine. In the engine room, where temperatures are at their highest, the risk of overheating is at its greatest and reliable fire prevention here is vital: as 3D data are often not available for older engines, retrofitting with SOLAS-compliant high-performance insulation systems has only been possible to a limited extent until now. With Tmax-Retrofit, older engines can now be efficiently upgraded with high-temperature insulation systems that not only meet but also exceed SOLAS standards. The Tmax-Retrofit all-in-one package provides customers with a comprehensive service, from needs assessment to installation of the completed insulation. This involves the preparation of the engine's 3D data and, if necessary, cooperation with the engine manufacturer. The service includes a 3D scan of the installed engine and CAD integration of the data, the design and manufacture and on-site installation of a suitable insulation system, and post-installation servicing of the system.

[www.thermamax.com](http://www.thermamax.com)

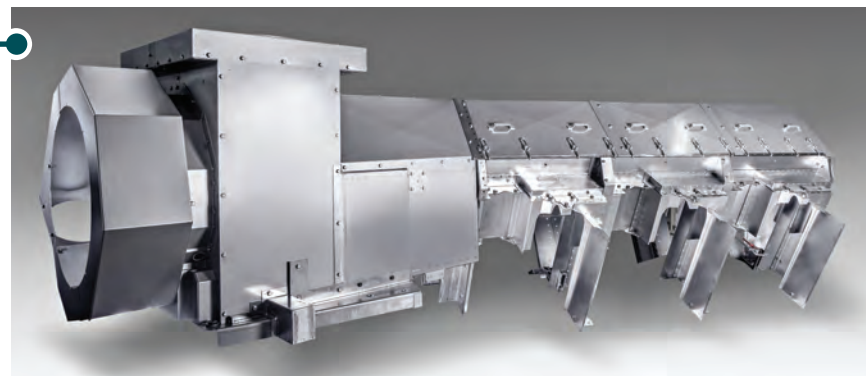

Thermamax

## Firetrol Fire Extinguishing System

The MX 1230 fire extinguishing system from Firetrol uses 3M Novec 1230 Fire Protection Fluid, which will not damage electronics and leaves no residue behind. It also has a higher safety margin than other clean agents, making it extremely safe for people working in protected areas. With 0.0 ozone depletion potential, an atmospheric lifetime of just five days, and a global warming potential of 1.0, the MX 1230 system offers a long-term alternative to Halon or carbon dioxide. Firetrol's exclusive 725 psi system allows longer pipe runs, smaller pipe sizes, remote tank location, and multi-zone protection from a single cylinder bank. As the only Novec 1230 system approved for use with selector valves, Firetrol can deliver cost savings and system flexibility for large area protection. This is the only USCG-approved 725 psi system on the market.

[www.firetrol.com](http://www.firetrol.com)



Firetrol

**The Maritime Propulsion Marketplace is the best way to sell your marine diesel engines and spare parts.**

**Try it now for free.**

**MARITIME  
PROPULSION**  
*Powering the Maritime Industry*

[www.maritimepropulsion.com](http://www.maritimepropulsion.com)



# The Maritime Industry's Largest Social Media Presence

*Maritime Reporter is a member of the Marine Media Network of websites, publications, and social media sources for news, editorial and information including the Maritime Network, the commercial marine industry's largest dedicated LinkedIn group.*



**63,523**  
Facebook Page  
Likes

**MARITIME  
REPORTER**  
AND  
ENGINEERING NEWS



**130,096**  
LinkedIn Group  
Members  
(industry's largest)



**31,453**  
Twitter  
Followers

**@ShipNews**

## Also part of the Marine Media Network



Page	Likes
Marine Electronics	33,528
Marine Technology Reporter	55,692
Maritime Global News	26,157
Maritime Jobs	46,011
Maritime Logistics Professional	30,947
Maritime Propulsion	22,477
Maritime Reporter & Engineering News	63,515
World Energy News	49,498

All stats from 01/02/2018

# A Shipyards

## A.1 Repair & Conversion

**Viega**  
 12303 Airport Way, Suite 395  
 Broomfield, CO 80021  
 Phone: 800-976-9819  
 Contact: Marine/Shipbuilding Inside Sales  
 Email: marine@viega.us



# C Hydraulic and Pneumatic

## C.1 Valves

**J A MOODY**  
 MARINE SALES & SERVICE  
 Veteran Owned Small Business  
 ISO 9001:2015 CERTIFIED

Your One Stop Source for Marine and Navy Valves Butterfly, TOTS, Multi-Turn, PRV and Composite!  
**WWW.JAMOODY.COM**  
 FOR AN EXPRESS QUOTE PLEASE  
 EMAIL: SALES@JAMOODY.COM

# E Ship Safety

## E.1 Fire Warning & Protection

**FIREBOY - XINTEX**  
**AETNA ENGINEERING**

PHONE: (616) 735-9380 TOLL FREE: (866) 350-9500  
**fireboy-xintex.com**  
 0-379 Lake Michigan Dr N.W. | Grand Rapids, MI 49534

# B Propulsion

## B.1 Gas Turbines

### Marine gas turbine propulsion systems & solutions

LNG carriers • LNG container ships • Hydrofoils • Fast ferries • Cruise ships • Offshore platforms • FPSOs • Naval ships • High-speed yachts



One Neumann Way, MD S156, Cincinnati, OH 45215  
 cheol.park@ge.com  
 Phone: +82-2-6201-3012, Fax: +82-10-3954-3337  
 www.ge.com/commercialmarine

Pipe, Valves, Fittings, and so much more.



+1 800.962.9696 • wosupply.com

# F Deck Machinery

## F.1 Cranes

**APPLETON MARINE, INC.**  
 3030 E. Pershing St. • Appleton, WI U.S.A. 54911-8671  
 (920) 738-5432 • Fax: (920) 738-5435  
**CRANES, WINCHES, ANCHOR WINDLASSES AND CAPSTANS**  
**www.appletonmarine.com**

## B.2 Engine Service & Repair

**OEM Spare Parts and 24/7 Engine Service**  
**www.mshs.com**  
 +1 954-763-3660 | info@mshs.com  
**MSHS** Motor-Services Hugo Stamp, Inc.  
 Authorized Distributor and Service Center

# D Chafe Gear

## D.1 Chafe Gear

**Chafe-Pro**  
 Don't Dock Without It!

**PROTECT YOUR INVESTMENT**  
 Chafe-Pro® is the preferred chafe gear of the USN, USCG and maritime industry around the world.  
**www.ChafePro.com**  
 1-844-NO-CHAFE

**DMWMARINEGROUP**  
**marine cranes**  
 Knuckle Boom | Telescoping | Small Marine | Special Application  
**www.dmwmarinegroup.com** • 610.827.2032

## F.2 Winches

**JonRie InterTech, LLC**  
 982 Whispering Oak Circle  
 Manahawkin, NJ 08050  
 Contact - Brandon Durar  
 bjdme@marinewinch.com  
 (609) 978-3523

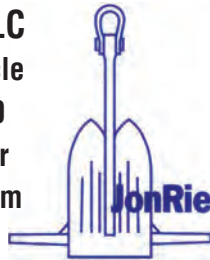

The industry's premier online news source  
**MarineLink.com**  
 - contracts  
 - offshore  
 - security  
 - company news



# G Ropes

## G.1 Chafe Gear



**PROTECT YOUR INVESTMENT**  
Chafe-Pro® is the preferred chafe gear of the USN, USCG and maritime industry around the world.  
www.ChafePro.com  
1-844-NO-CHAFE

# J Ship Equipment

## J.1 Helm Chairs



MARINE SEATING FROM LLEBROC  
**On the Leading Edge of Marine Seating.**  
WWW.LLEBROC.COM • 800.284.5771

# H Marine Safety Equipment

## H.1 Safety & Survival Gear

**STEARNS®**  
THE LIFE JACKET EXPERTS™  
The Coleman Company, Inc  
3600 N. Hydraulic  
Wichita, KS 67219  
1.800.835.3278  
www.coleman.com  
www.stearnsfloatation.com

## J.2 Flow Control Products



Your One Stop Source for Marine and Navy Valves Butterfly, TOTS, Multi-Turn, PRV and Composite!  
WWW.JAMOODY.COM  
FOR AN EXPRESS QUOTE PLEASE EMAIL: SALES@JAMOODY.COM  
Veteran Owned Small Business  
ISO 9001:2015 CERTIFIED

# K Fire Safety Equipment

## K.1 Fire Safety Products



**WESTERN FIRE & SAFETY**  
SEATTLE, WA  
The only 2.5 Gallon AFFF USCG Approved Foam Fire Extinguisher in the USA.  
www.westernfireandsafety.com  
sales@westernfireandsafety.com  
Ph:(206)782-7825 • Fx:(206)783-5748

# I Ship Design

## I.1 Consulting Engineers

**Viega**  
12303 Airport Way, Suite 395  
Broomfield, CO 80021  
Phone: 800-976-9819  
Contact: Marine/Shipbuilding Inside Sales  
Email: marine@viega.us



Join the industry's #1 LinkedIn group  
**THE MARITIME NETWORK**  
http://bit.do/MaritimeNetwork



# IMPACT SYSTEM™

Interactive Media Performance and Campaign Tracking

Give your online advertising real **IMPACT**- an exclusive tracking tool for online advertisers.

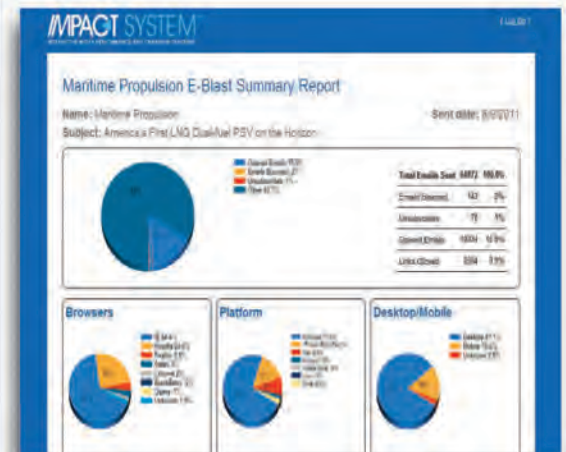

**IMPACT** platform displays data and traffic from:

- Browsers
- Platforms
- Desktop / Mobile
- Countries

Take control of your campaign- only from New Wave Media.

Track your banner ad exposure in real time, with an easy interface

- Impressions
- Clicks
- Click Through Rate
- Unique IPs

Access a complete report of your Eblast campaign's success.

- Total Emails Sent
- Opened Emails
- Links Clicked

Available for all online/email advertising programs, only from New Wave Media. For more information, contact your representative, or call our offices: (212) 477-6700

# BUYER'S DIRECTORY

This directory section is an editorial feature published in every issue for the convenience of the readers of MARITIME REPORTER. A quick-reference readers' guide, it includes the names and addresses of the world's leading manufacturers and suppliers of all types of marine machinery, equipment, supplies and services. A listing is provided, at no cost for one year in all issues, only to companies with continuing advertising programs in this publication, whether an advertisement appears in every issue or not. Because it is an editorial service, unpaid and not part of the advertisers contract, MR assumes no responsibility for errors. If you are interested in having your company listed in this Buyer's Directory Section, contact Mark O'Malley at [momalley@marinelink.com](mailto:momalley@marinelink.com)

## ALIGNMENT & INSPECTION SERVICES

Aiman Alignment Services, 36938 Chancey Rd  
Zephyrills, FL 33541, tel:(813) 715-4600,  
[sales@aimanalignment3d.com](mailto:sales@aimanalignment3d.com)

## ANCHORS & CHAINS

Anchor Marine & Supply, INC., 6545 Lindbergh Houston,  
Texas 77087, tel:(713) 644-1183, fax:(713) 644-1185,  
[david@anchormarinehouston.com](mailto:david@anchormarinehouston.com)

## AUTOMATIC IDENTIFICATION SYSTEM

Saab AB (publ) TransponderTech, SE-589 41 Linkoping,  
tel:46 13 180000, fax:46 13 182377,  
[Info.transpondertech@saabgroup.com](mailto:Info.transpondertech@saabgroup.com)

## CABLES

Helkama Bica Oy, Lakimiehenkatu 4, KAARINA FI-  
20780, Finland, tel:+358-2-410 8700,  
[sales@helkamabica.fi](mailto:sales@helkamabica.fi), [www.helkamabica.com](http://www.helkamabica.com)

## COMMUNICATIONS

David Clark Company (Wireless Headset  
Communication Systems), 360 Franklin Street,  
Worcester, MA 77060, USA, tel:(800) 298-6235,  
[www.davidclarkcompany.com/marine](http://www.davidclarkcompany.com/marine)

## DECK MACHINERY- CARGO HANDLING EQUIPMENT

Allied Systems Company, 21433 SW Oregon Street,  
Sherwood, OR 23462, USA, tel:(503) 625-2560,  
[cranes@alliedsystems.com](mailto:cranes@alliedsystems.com), [www.alliedsystems.com](http://www.alliedsystems.com)

## EDUCATION

San Jacinto College, 8060 Spencer Highway Pasadena, TX  
77505

## EXHAUST

Marine Exhaust Systems of Alabama, 757 Nichols Ave.,  
Fairhope, AL, USA, tel:(251) 928-1234,  
[mark@mesamarine.com](mailto:mark@mesamarine.com), [www.mesamarine.com](http://www.mesamarine.com)

## EXPANSION JOINTS

Elasto-Valve Rubber Products Inc., 1691 Pioneer Rd,  
Sudbury, ON P3G 1B2, Canada, tel:(705) 523-2026,  
fax:(705) 523-2033, [sales@evrproducts.com](mailto:sales@evrproducts.com)

## FIRE FIGHTING

In-Mar Solutions, LLC, 3011 S Ruby Avenue Gonzales,  
LA 70737 USA, tel:(225) 644-7063 ext 15,  
[toby@inmarsolutions.com](mailto:toby@inmarsolutions.com) contact: Toby Whitfield,  
[www.inmarsolutions.com](http://www.inmarsolutions.com)

## FUEL TREATMENT

Advanced Power Systems / Fitch Fuel Catalyst, 18  
Hemlock Drive New Hartford, CT.06057, USA, tel:860-  
921-0009, [info@fitchfuelcatalyst.com](mailto:info@fitchfuelcatalyst.com),  
[www.fitchfuelcatalyst.com](http://www.fitchfuelcatalyst.com)

## HYDRAULIC BRAKE CALIPERS

Twiflex by Altra Industrial Motion, 2800 Fisher Road,  
Wichita Falls, TX, USA, tel:(844) 723-3483,  
[twiflex.info@twiflex.com](mailto:twiflex.info@twiflex.com),  
[www.altramotion.com/market/marine/home](http://www.altramotion.com/market/marine/home)

## HYDRAULIC SYSTEMS

Bay Ship & Yacht Co, 2900 MAIN ST. #2100 ALAMEDA,  
CA 94501 USA, tel:(510) 337-9122, [rmaguire@bay-ship.com](mailto:rmaguire@bay-ship.com) or [ndelgavio@bay-ship.com](mailto:ndelgavio@bay-ship.com) contact: Richard  
Maguire or Nick Del Gavio, [www.bay-ship.com](http://www.bay-ship.com)

## INERTIAL SENSING SYSTEMS

Silicon Sensing Systems Ltd, Clifftaford Road Southway,  
Plymouth, Devon PL6 6DE United Kingdom, UK,  
tel:+44 (0) 1752 723330, [sales@siliconsensing.com](mailto:sales@siliconsensing.com)

## LIFT EQUIPMENT

Lifting Gear Hire, 9925 Industrial Drive Bridgeview, IL  
60455, tel:708 598-4727 ext 111,  
[christina.Czeszewski@lgh-usa.com](mailto:christina.Czeszewski@lgh-usa.com)  
Tandemloc, 824 Highway 101(FONTANA BLVD)  
HAVELOCK, NC 28532

## MARINE TRANSPORTATION

Central Boat Rentals, Inc., P.O. Box 2545, Morgan City,  
LA, USA, tel:985-384-8200, fax:985-384-8455,  
[earl@centralboat.com](mailto:earl@centralboat.com) or [gary@centralboat.com](mailto:gary@centralboat.com)

## MARITIME TRAINING & SCHOOLS

El Camino College, 13430 Hawthorne Blvd., Hawthorne,  
CA, USA, tel:(310) 973-3147, [psutton@elcamino.edu](mailto:psutton@elcamino.edu)

## MECHANICALLY ATTACHED FITTINGS (MAFS)

Viega, Mountain View Corporate Center Building 1,  
Suite 395 12303 Airport Way, Broomfield, CO, USA,  
tel:904-315-3899, fax:888-782-6188,  
[paul.switzer@viega.us](mailto:paul.switzer@viega.us) contact: Paul Switzer,  
[www.viega.us](http://www.viega.us)

## MEMS MOTION SENSING

Silicon Sensing Systems Ltd, Clifftaford Road Southway,  
Plymouth, Devon PL6 6DE United Kingdom, UK,  
tel:+44 (0) 1752 723330, [sales@siliconsensing.com](mailto:sales@siliconsensing.com)

## MILITARY PATROL CRAFT MANUFACTURERS

Brunswick Commercial & Government Products, 420  
Megan Z Avenue, Edgewater, FL 80204, USA, tel:(386)  
423-2900, [kelsey.nemeth@whaler.com](mailto:kelsey.nemeth@whaler.com),  
[www.brunswickcgp.com](http://www.brunswickcgp.com)

## NAVAL ARCHITECTS, MARINE ENGINEERS

Bristol Harbor Group, Inc., 99 Poppasquash Road Unit  
H, Bristol, RI, USA, tel:(401) 253-4318,  
[kribeiro@bristolharbargroup.com](mailto:kribeiro@bristolharbargroup.com)

Brunswick Commercial & Government Products, 420  
Megan Z Avenue, Edgewater, FL 80204, USA, tel:(386)  
423-2900, [kelsey.nemeth@whaler.com](mailto:kelsey.nemeth@whaler.com)

Gilbert Associates, 100 Grossman Dr. Suite 205  
Braintree, MA 02184 USA, tel:(781) 740-8193,  
[jgilbert@jwgainc.com](mailto:jgilbert@jwgainc.com) contact: John Gilbert,  
[www.jwgainc.com](http://www.jwgainc.com)

The Shearer Group, Inc, 3118 Harrisburg Blvd., Suite  
100, Houston, TX, USA, tel:(281) 532-2080,  
[gbeers@bristolharbargroup.com](mailto:gbeers@bristolharbargroup.com)

## PASSENGER AND COMMERCIAL VESSEL REPAIR, MAINTENANCE, DRYDOCKING

Blohm+Voss B.V. & Co. KG, Hermann-Blohm-Strasse 3,  
20457 Hamburg, Germany Germany, tel:+49 (0) 40 3119  
1400, [shipservices@blohmvooss.com](mailto:shipservices@blohmvooss.com),  
[www.blohmvooss.com](http://www.blohmvooss.com)

## PIPING SYSTEMS FOR SHIP REPAIR & NEW CONSTRUCTION

Viega, Mountain View Corporate Center Building 1,  
Suite 395 12303 Airport Way, Broomfield, CO, USA,  
tel:904-315-3899, fax:888-782-6188,  
[paul.switzer@viega.us](mailto:paul.switzer@viega.us) contact: Paul Switzer,  
[www.viega.us](http://www.viega.us)

## PRESS FITTINGS

Viega, Mountain View Corporate Center Building 1,  
Suite 395 12303 Airport Way, Broomfield, CO, USA,  
tel:904-315-3899, fax:888-782-6188,  
[paul.switzer@viega.us](mailto:paul.switzer@viega.us) contact: Paul Switzer,  
[www.viega.us](http://www.viega.us)

## PROPULSION - HYBRIDRIVE SOLUTIONS

BAE Systems - HybriDrive Solutions, 1098 Clark Street,  
Endicott, NY 13760, tel:(607) 770-2083,  
[carol.gorenflo@baesystems.com](mailto:carol.gorenflo@baesystems.com) contact: Carol  
Gorenflo

## PROPULSION EQUIPMENT AND SERVICES

(Twiflex) by Altra Industrial Motion, 2800 Fisher Road,  
Wichita Falls, TX, USA, tel:(844) 723-3483,  
[twiflex.info@twiflex.com](mailto:twiflex.info@twiflex.com), [www.twiflex.com](http://www.twiflex.com)

## SEATING

In-Mar Solutions, LLC, 3011 S Ruby Avenue Gonzales,  
LA 70737 USA, tel:(225) 644-7063 ext 15,

[toby@inmarsolutions.com](mailto:toby@inmarsolutions.com) contact: Toby Whitfield,  
[www.inmarsolutions.com](http://www.inmarsolutions.com)

## SHIPBUILDING-REPAIRS, MAINTENANCE, DRYDOCKING

St. John's Ship Building, 560 STOKES LANDING ROAD  
Palatka, FL 32177, USA, tel:386-328-6054,  
[sganoe@stjohns-ship.com](mailto:sganoe@stjohns-ship.com) contact: Steve Ganoe,  
[www.stjohnsshipbuilding.com](http://www.stjohnsshipbuilding.com)

## SHIPYARDS

Grand Bahama Shipyard Limited, P.O. Box F-42623,  
Freeport, Grand Bahama, Bahamas, tel:+1 242-350-  
4000, [enquiries@gbshipyard.com](mailto:enquiries@gbshipyard.com)

## STORAGE, DOCKAGE & REPAIRS

Jacksonville Marine Center, 1901-C HILL STREET  
JACKSONVILLE, FL 32202, tel:904-559-1020,  
[lsnyder@stjohns-ship.com](mailto:lsnyder@stjohns-ship.com) contact: Lisa Snyder,  
[www.jaxmarinecenter.com](http://www.jaxmarinecenter.com)

## SURFACE PREP TOOLS

Water Cannon, 4300 West Lake Mary Blvd. Units 1010-  
424, USA, tel:321-800-5763, [sales@watercannon.com](mailto:sales@watercannon.com),  
[www.watercannon.com](http://www.watercannon.com)

## VALVES

Wager Company Inc., 570 MONTROYAL RD Rural Hall, NC  
27045

## VIBRATION ANALYSIS

Advanced Mechanical Enterprises, 217 SW 28th Street  
Fort Lauderdale, FL 33315, tel:(954) 764-2678,  
[Joanna@AMEsolutions.com](mailto:Joanna@AMEsolutions.com) contact: Joanna Ramirez

## VIBRATION AND THERMOGRAPHY (IR) TESTING AND PROGRAMS

Condition Analyzing Corp, 23 White Street, Eatontown,  
NJ, USA, tel:800 586-8435,  
[cac@cacvibe.com](mailto:cac@cacvibe.com), [www.cacvibe.com](http://www.cacvibe.com)

## WASTE WATER TREATMENT

Scienco/Fast - a division of Bio-Microbics, 12977 Maurer  
Industrial Drive, Sunset Hills, MO, USA, tel:+1 314-756-  
9300, fax:+1 314-756-9306, [solutions@sciencofast.com](mailto:solutions@sciencofast.com)

## WINDSCREEN & WINDOW WIPERS

In-Mar Solutions, LLC, 3011 S Ruby Avenue Gonzales,  
LA 70737 USA, tel:(225) 644-7063 ext 15,  
[toby@inmarsolutions.com](mailto:toby@inmarsolutions.com) contact: Toby Whitfield,  
[www.inmarsolutions.com](http://www.inmarsolutions.com)

**"Maritime Reporter is our  
least expensive sales  
person."**

- Doug Weidner, DMW Marine Group

For the last 75 years, industry executives  
have turned to the pages of *Maritime  
Reporter* for unparalleled news, editorial  
and information.

By advertising in *Maritime Reporter*, your  
ad will reach a 100% requested circula-  
tion of 34,576, audited by the BPA.

Contact us today to find out how we can  
help you grow your business.

Maritime Reporter & Engineering News

118 East 25th Street, New York, NY 10010

Tel: +1-212-477-6700 [howard@marinelink.com](mailto:howard@marinelink.com)

[www.marinelink.com](http://www.marinelink.com)



**MAXIMIZE YOUR POTENTIAL.**



Find your new career at:  
**MaritimeJobs.com**

[www.MaritimeJobs.com](http://www.MaritimeJobs.com)

MARINE AND INDUSTRIAL SERVICES

---

J. GOODISON  
COMPANY, INC.

---

FOR IMMEDIATE HIRE!  
SENIOR MARINE ESTIMATOR

- 10+ years marine estimating and bidding experience required
- Travel may be required
- Excellent communication skills required
- Competitive salary and benefits package



Please call (401) 667-5935  
North Kingstown, RI

### Pilot

Full Time

Category: Vessel Operations

Description:

Cheryl K is now accepting applications for licensed wheelhouse pilots and experienced deck crew.

Pilots must have valid USCG License- Inland Waters, Western Rivers Towing and Radar Occasional tramp work Houston to Morgan City.

### Ocean Going Tug Engineer

32 POINTS MANNING

Salary: \$ 500-550/DAY , Full Time , Engineer

Description:

DDE or Licensed Engineer for Ocean Going Tug and C/E. TUG ENGINEER NEEDED SOON DDE or Licensed Engineer for an Ocean Going Tug leaving or ASAP from the Gulf of Mexico. Tug Experience preferred but willing to consider Chiefs from the Oil Patch. Mariner pays no fee for placement. \$500-550/day depending on background. Benefits package available Must have a current valid physical. US Flagged vessel. You must have a valid USCG MMD. Contact me at 818-481-3311 Marcus McNeill. website: [www.32pointsmanning.com](http://www.32pointsmanning.com) email : [marcus@32pointsmanning.com](mailto:marcus@32pointsmanning.com)

### Chief Engineer

Salary: \$ negotiable , Full Time , Company Employee

Category: Sales / Marketing

Job Location: Scienco/FAST 12977 Maurer Industrial Drive Sunset Hills, Missouri, 63127 USA

Contact

President

Email: [rrebori@biomicrobics.com](mailto:rrebori@biomicrobics.com)

Work Phone : 9134220707

Scienco/FAST 12977 Maurer Industrial Drive Sunset Hills, Missouri, 63127 USA

Skills:

General Sales and Engineering skills for on board water and waste water treatment systems of certified IMO MSDs.

Description:

Chief Engineer with generak engineering and sales skills with moderate travel for OEM in St. Louis, Missouri, USA.

### Liferaft Service Technician

Salary: \$ \$18 to \$22 , Full Time , Company Employee

Category: Shoreside Operations

Job Location: 290 Beltway Green Blvd. Suite 400 Deer Park, Texas, 77536 United States

Contact

HR Consultant

Email: [rodney.williams@survitecgroup.com](mailto:rodney.williams@survitecgroup.com)

Work Phone : 713-993-7734

290 Beltway Green Blvd. Suite 400 Deer Park, Texas, 77536 United States

Skills:

Survitec is a global leader in survival and safety solutions to the marine, defense, aviation and offshore markets. Survitec has over 3,000 employees worldwide covering 8 manufacturing facilities, 15 offshore support centers and over 70 owned service stations. It is further supported by a network of over 500 3rd party service stations and distributors. Across its 160-year history, Survitec Group has remained at the forefront of innovation, design and application engineering and is the trusted name when it comes to critical safety and survival solutions.

### Marine Surveyor/Consultant

Fernandes Maritime Consultants, LLC

Full Time , Mid Career

Category: Shoreside Operations

Skills:

Master/Ch. Officer/Ch. Engr. license/COC

Description:

Marine surveying and consulting firm seeks experienced

and responsible surveyor(s) for Mobile and/or New Orleans office. Master/Ch. Officer/Ch. Engr. license/COC essential. Experience in H&M and P&I surveys a plus. Must be in U.S. and proficient in English. Competitive salary and benefits incl. Health and 401-K.

### Field Service Technician

Hug Engineering, Inc.

Full Time

Job Location: 4961 Golden Parkway Buford, GA, 30518 United States

Contact

Spanjic

Email: [manuela.spanjic@hug-engineering.com](mailto:manuela.spanjic@hug-engineering.com)

4961 Golden Parkway Buford, GA, 30518 United States

Job Description

To expand our team Hug Engineering is looking for an experienced Field Service Technician to provide technical support/service to customers during the complete life of the equipment. You will provide technical support and physical assistance to customer by identifying problems associated with the operation of our equipment.

The successful applicant will provide start-up and emergency field service support. Common sense judgement and discretion in combination with technical skills are required. Performance of daily tasks will require extensive travel including weekends in the 80+ percent range, some international travel to Europe is expected and will be required.

### FY18-14 Assistant Director, Career & Professional Services

Massachusetts Maritime Academy

Salary: \$ \$50,000 to \$55,000 , Full Time , Mid Career

Category: Corporate / Senior Management

Job Location: 101 Academy Drive Buzzard Bay, MA, 02532 USA

Contact

Email: [cruggeri@maritime.edu](mailto:cruggeri@maritime.edu)

Work Phone : 508.830.5000

101 Academy Drive Buzzards Bay, MA, 02532 USA

General Statement of Duties: The Assistant Director works with the license-track students and maritime employers, developing and maintaining partnerships with employers in order to facilitate permanent job opportunities for MMA students in the Marine Transportation and Marine Engineering programs. The Assistant Director represents all majors at the Academy when conducting employer outreach.

LICENSED PROFESSIONALS  
WORLDWIDE VESSEL DELIVERY

Masters, Engineers and Crews



BAYFRONT MARINE, INC.  
MARINE SERVICES

[www.bayfrontmarineinc.com](http://www.bayfrontmarineinc.com)  
[bfm@bayfrontmarineinc.com](mailto:bfm@bayfrontmarineinc.com)  
 Contact Mel or Diane Longo 904-824-8970



BOKSA

MARINE DESIGN

813-654-9800  
INFO@BMDINC.COM  
BOKSAMARINEDESIGN.COM

Engineered for the Sea

DESIGN • NAVAL ARCHITECTURE • ENGINEERING





GEORGE G. SHARP, INC.

160 BROADWAY, NEW YORK, NY 10038  
TEL (212) 732-2800 FAX (212) 732-2809

WASHINGTON	(703) 835-9998
VIRGINIA BEACH	(757) 499-4125
SAN DIEGO	(619) 425-4211

MARINE SYSTEMS • ANALYSIS & DESIGN

**C. R. CUSHING & Co., Inc.**  
NAVAL ARCHITECTS • MARINE ENGINEERS • TRANSPORTATION CONSULTANTS

30 VESEY ST  
7TH FLOOR  
NEW YORK, NY  
10007

SINCE  
**1968**

Ph: (212) 964-1180  
Fax: (212) 285-1334  
info@crcco.com  
www.crcco.com

SPECIALISTS IN THE DESIGN OF:

- OFFSHORE SUPPORT VESSELS
- TUGS AND TOWBOATS
- BARGES
- HIGH SPEED CRAFT
- NAVAL VESSELS
- CREWBOATS
- SPECIAL PURPOSE VESSELS
- YACHTS



DESIGN, CONSULTING, SURVEYING AND DRAFTING SERVICES

**GUARINO & COX, LLC**  
Naval Architects, Marine Designers and Consultants  
19399 Helenburg Road Suite 203 Covington, LA 70433  
Tel: (985) 871-9997 Fax: (985) 871-9927 www.guarino-cox.com

**Technology Associates, Inc.**  
*Bringing Engineering to Successful Fruition*



■ [www.TAIEngineers.com](http://www.TAIEngineers.com) ■  
(504) 282-6166

**Established in 1854**

**GRANDALL  
DRY DOCK ENGINEERS, INC.**  
• Consulting • Design • Inspection  
Railway and Floating Dry Docks  
Dry Dock Hardware and Equipment

552 MacArthur Blvd. Bourne, MA 02532  
(617)884-8420 • (888)DRY-DOCK  
[www.crandalldrydock.com](http://www.crandalldrydock.com)

**HEGER DRY DOCK INC.**  
Marine Structural Engineers



Engineering for all types of drydocks

- Design
- Consultation
- Appraisals
- Inspections
- Certifications
- US Navy MIL-STD FCR
- Docking Calculations
- Mooring Designs
- Accident Investigations
- Drydocking Seminars

77 Main St., Suite 9, Hopkinton, MA 01748 | [hegerdrydock.com](http://hegerdrydock.com)  
Phone : (508) 429-1800 | Fax : (508) 429-1811

**General HydroStatics (GHS)**

New Feature in 2018:  
6-DOF Frequency-domain Seakeeping Module.

- Still Industry-Leading:  
Multi-Body Module for Rollon/off Studies, Salvage and More
- Advanced On-board (GLM) Features:  
Loading Automation Support with Sensor Interfaces  
Automatic Ballast-water Logs with GPS Coordinates  
And Many More

[www.ghsport.com](http://www.ghsport.com)

**GHS**  
General HydroStatics

**Ship Stability and Strength Software**

GHS ..... Full-featured naval architect's system  
GHS Load Monitor (GLM) ..... Onboard configuration  
BHS ..... Basic hydrostatics and stability

**Creative Systems, Inc.**  
Creators of GHS™

P.O. Box 1910 Port Townsend, WA 98368 USA  
phone: (360) 385-6212 email: [sales@ghsport.com](mailto:sales@ghsport.com)

[www.GHSport.com](http://www.GHSport.com)

For 46 years, the software that naval architects love.

**HEC**  
Herbert Engineering Corp.



**SHIP DESIGN & ENGINEERING SERVICES**  
*Design Innovation • Fleet Optimization •  
Improved Environmental Performance  
• Regulatory Analysis •*

Helping owners find the best ballast  
water treatment and post-2020 fuel options

510-814-9700 • [www.herbert.com](http://www.herbert.com)

**M.A.C.E.**

Marine Industry

FT. LAUDERDALE - USA - WORLDWIDE  
PHONE: (954) 563-7071 FAX: (954) 568-6598

- N.D.T Services
- Vibration - noise - structural/modal analysis
- Field balancing, Laser Alignment
- Torque - torsional vibration analysis
- IR - Thermography inspection
- Emmision tests, Engine Performance tests
- Low Location Light Testing

CG State Pilotate License Insurance/ Mariners' Disability Insurance  
For Quotes on License Insurance or Mariners' Disability Insurance  
See our web site: [marinelicenseinsurance.com](http://marinelicenseinsurance.com)

**R.J. MELLUSI & CO.**  
29 Broadway, Suite 2311  
New York, N.Y 10006  
Ph: (212) 962-1590  
Fx: (212) 385-0920  
[Rjmellusi@sealawyers.com](mailto:Rjmellusi@sealawyers.com)



**GILBERT ASSOCIATES, INC.**  
Naval Architects  
and Marine Engineers



100 Grossman Dr. Suite 205  
Braintree, MA 02184  
T: (781) 740-8193 • F: (781) 740-8197  
E-mail: [JGilbert@jwgainc.com](mailto:JGilbert@jwgainc.com)  
[www.jwgainc.com](http://www.jwgainc.com)

**LAY, PITMAN & ASSOCIATES, INC.**  
NAVAL ARCHITECTS

- Naval Architecture Services
- Marine Engineering
- Design Services
- Construction Administration
- Regulatory Liaison
- Inspections and Surveys

2300 Marsh Point Road #303  
Neptune Beach, Florida 32266  
(904) 221-7447 • [www.laypitman.com](http://www.laypitman.com)

**MINO**  
Marine, LLC

Naval Architects and  
Marine Engineers  
Design and Analysis • FEA • CFD

119 Causeway Boulevard • New Orleans, LA 70121  
504-218-8162 • [www.minomarine.com](http://www.minomarine.com)

**MARITIME  
PROPULSION**

Maritime Propulsion is the largest online  
database for marine power & propulsion  
equipment - the  
fastest way to find  
engine reports,  
specs, suppliers,  
and exclusive  
articles on industry  
developments.



[www.maritimepropulsion.com](http://www.maritimepropulsion.com)

**2000' PERMITTED BARGE FLEET**  
 West Bank of Michoud Canal at New Orleans  
 off Gulf Intracoastal Waterway east of Inner  
 Harbor Locks, inside surge protection barrier.  
 Contact Paul Ramoni  
**504-813-7787 • peramoni@gmail.com**



**Tank Tender**  
**THE ORIGINAL PRECISION**  
**TANK MEASURING SYSTEM!**  
 Accurate tank soundings have never been easier  
 when one **TANK TENDER** monitors up to ten fuel and  
 water tanks. Reliable non-electric and easy to install.  
 HART SYSTEMS, INC. [www.TheTankTender.com](http://www.TheTankTender.com)  
 (253) 858-8481 • FAX (253) 858-8486



**RUSTIBUS®**  
 maintaining your values  
**THE MOST POWERFUL TOOL**  
 for removing coatings and rust  
 USA OFFICE Ph: 832-203-7170  
 houston@rustibus.com  
[www.rustibus.com](http://www.rustibus.com)



**AIMAN ALIGNMENT**  
**3D INSPECTION AND ALIGNMENT OF MACHINERY AND HULLS.**  
 USING LASER TRACKERS, CMM ARMS, TOTAL STATIONS,  
 3D PHOTOGRAMMETRY, STRAIN GAUGES, OPTICAL TOOLING.  
 SPECIALIZING IN PRECISION IN PLACE FIELD MACHINING.  
 Ph: 813-715-4600 • [sales@aimanalignment3d.com](mailto:sales@aimanalignment3d.com)

### Industrial – Grade Pressure Washers



**WATER CANNON .com**  
 CELEBRATING **35** YEARS OF SERVICE  
[WaterCannon.com](http://WaterCannon.com)  
**800.333.9274**

### OCEAN CHARTING SERVICES

For Improved Compliance &  
 Better Bridge Management

WEST COAST GREAT LAKES EAST COAST  
 Ocean Charting Services  
 Maintain Government Publications with our  
 Weekly Updates on DVD or USB Drives  
**FREE TRIAL**  
 2 Vessels - 2 Months  
 TIME SAVED PAYS FOR SERVICE  
[oceanchartingservices.com](http://oceanchartingservices.com) 410-820-9600

## We Build the Ship First.



**Production Lofting  
 Detail Design  
 3D Modeling**  
 St. John's, NL | Vancouver, BC | New Orleans, LA  
 709.368.0669 | 504.287.4310 | [www.genoadesign.com](http://www.genoadesign.com)  
**genoa**  
 DESIGN INTERNATIONAL

**POWERING THE MARINE INDUSTRY**  
 SINCE 1964!

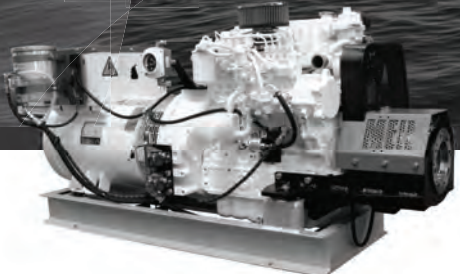

**8-500kW Marine Generators**  
 // Pull harder in the harshest marine environments  
 // More copper and premium corrosion resistance  
 // Superior motor starting and low operating temps  
 // Better fuel economy and longer engine life  
 // Easy to service and worldwide dealer support  
 // Proudly made in America

1.800.777.0714 toll free  
[www.merequipment.com](http://www.merequipment.com)  
**BOLLARD**  
 ENGINES & GENERATORS



**THE MARITIME NETWORK**  
 The maritime industry's largest group  
**JOIN TODAY!**  
  
**128,000 members**

**WILKES & MCLEAN**  
 Got Noise?  
**HYDRAULIC SUPPRESSOR**

Noise, Shock, Vibration & Pulsation In → Quiet, Smooth Flow Out



Oil Bladder Nitrogen (blue)  
 Three Stage Noise & Pulsation Reduction Chamber

**QUALITY NACOL ACCUMULATORS**  
 • No seam, pleated bladders  
 • Forged shells, no welds  
 • Long lasting, best built accumulators  
 • We stock 1/5 pint to 15 gallons in Chicago  
 • Sizes available to 40 gallons

**Nacol Accumulators**  
**pacific marine**  
 Visit us at booth # 950

Wilkes & McLean, Ltd.  
 877-534-6445  
[www.wilkesandmclean.com](http://www.wilkesandmclean.com)  
[info@wilkesandmclean.com](mailto:info@wilkesandmclean.com)





America's Crane and Handling Systems Company  
**Allied Marine Crane**  
 503.625.2560  
[www.alliedsystems.com/crane](http://www.alliedsystems.com/crane)



MARINE EXHAUST SYSTEMS OF ALABAMA INC.  
[www.mesamarine.com](http://www.mesamarine.com) • [marine.exhaust@gmail.com](mailto:marine.exhaust@gmail.com) • 1-251-928-1234

## Vesconite Hilube

### Rudder and Stern Tube Bearings

- Use dry or underwater
- No grease needed
- Lowest friction
- Fit and forget



Call for free Design Manual  
**1-866-635-7596**  
[www.vesconite.com](http://www.vesconite.com)

# MR

## Vessels, Barges & Real Estate for Sale/Rent



We buy barges, ships, and other marine vessels and structures for scrap. We adhere to the highest ES&H standards. Serving the rivers and coasts of the U.S.

AMELIA • BROWNSVILLE  
 LAKE CHARLES • MOBILE  
 MORGAN CITY • NEW ORLEANS  
[us.emrgroup.com](http://us.emrgroup.com)  
**CALL 800 - GO SCRAP**



**ZIDELL**  
 MARINE CORPORATION

Specializing In Barges

- Single or Double Hull, Inland or Ocean-Going
- Chartering & Sales

Ask for Bill Gobel  
 (503) 228-8691 • (800) 547-9259  
 2020 SW 4th Ave Suite 600  
 Portland, OR 97201



**Sell Your Ship or Work Boat and Pay Us No Commission!**

Ship-Locator.com is a user friendly website for ship and work-boat owners, ship brokers, lawyers and government officials selling vessels resulting from arrest and liens.

By selling your vessel yourself you only pay our very inexpensive listing fee of \$150.00 until your vessel sells or one year. Brokers can sell a single listing or sign up as a regular broker. Our broker listing fees are the lowest in the industry and you can have your own page! Our broker rates are very inexpensive, \$200.00 per month with no limit on listings or pictures! To learn more please browse through our site and contact us at 1-425-608-0280 U.S. Pacific Time or [gene@ship-locator.com](mailto:gene@ship-locator.com)

We get listings from around the world. Our Google language translation lets people around the world read your ad! We work with your print ad by increasing the amount of information you can put in front of a prospective buyer. Call Us For Details and Options.

**This Month Featured Ship**



1974 135 Feet USA 0000 Tons

Asking \$450 K  
 5750 HP\* New steel yr 14/15  
 New gen sets yr 14/15\* Over \$700 K spent in 2017\* Go to ship ID # 363. Owner is very motivated



**IMPACT SYSTEM™**  
 Interactive Media Performance and Campaign Tracking



Available for all online/email ad programs, only from New Wave Media. For details, contact your rep or call our offices: (212) 477-6700

**SEE YOUR DIGITAL CAMPAIGN RESULTS IN REAL TIME**

# ADVERTISER INDEX

Page	Advertiser	Website	Phone #
13	.AER	.www.aersupply.com	.(800) 767-7606
47	.Anchor Maine & Supply, Inc	.www.anchormarinehouston.com	.(800) 233-8014
C2	.BAE Systems - HybriDrive Solutions	.www.HybriDrive.com	.(607) 770-2083
27	.Citgo Petroleum Lubrication	.www.ClarionEnviroSafety.com	.(855) 692-5274
21	.Click Bond, Inc.	.www.clickbond.com/MR12	.(775) 885-8000
45	.DCL Mooring and Rigging	.www.dcl-usa.com	.(800) 228-7660
25	.DNV-GL	.www.dnvgl.us/maritime	.(281) 396-1000
45	.Ebac Systems	.www.ebacusa.com	.(757) 873-6800
31	.Fireboy-Xintex Inc	.www.fireboy-xintex.com	.(616) 735-9380
1	.Glosten	.www.glosten.com	.(206) 624-7850
5	.Hydrogenics	.www.hydrogenics.com	.(905) 361-4574
17	.Interferry 2018	.www.InterferryConference.com	Please visit us online
11	.Louisiana Cat	.www.LouisianaCat.com/Marine	.(866) 843-7440
15	.Motor Services Hugo Stamp, Inc.	.www.mshs.com	.(954) 763-3660
53	.Offshore Northern Seas	.www.ons.no	Please visit us online
43	.Omnithruster	.www.omnithruster.com	.(330) 963-6310
C4	.Pacific Green Marine Technologies	.www.pacificgreenmarine.com	Please visit us online
23	.Poseidon Barge, LTD	.www.poseidonbarge.com	.(260) 422-8767
7	.SMM 2018 Hamburg	.www.smm-hamburg.com/trailer	Please visit us online
23	.Tandemloc	.www.tandemloc.com	.(800) 258-7324
3	.The Switch Engineering Oy	.www.theswitch.com	.358 20 783 8200
9	.Thordon Bearings Inc.	.www.ThordonBearings.com	Please visit our website
25	.Transas Marine Ltd	.www.transas.com	Please visit us online
37	.Viega	.www.viega.us/About-us	.(800) 976-9819
31	.W&O Supply	.www.wosupply.com	.(800) 962-9696
C3	.World Energy Reports	.www.worldenergyreports.com	.(212) 477-6700

**Download the all new Maritime GlobalNews App from *Maritime Reporter*. All the relevant industry news at your fingertips.**

The listings above are an editorial service provided for the convenience of our readers. If you are an advertiser and would like to update or modify any of the above information, please contact: [productionmanager@marinelink.com](mailto:productionmanager@marinelink.com)



# TRACK FUTURE CONSTRUCTION REQUIREMENTS FOR FLOATING PRODUCTION SYSTEMS WITH REAL TIME MARKET ANALYSIS



## FORECASTS AND MARKET INTELLIGENCE FOR THE GLOBAL FLOATING PRODUCTION MARKET

### THERE IS NOTHING ELSE LIKE IT ANYWHERE ELSE!

This comprehensive business intelligence service and online database provides insider access to business and investment opportunities in the deepwater global floating production sector.



- **MONTHLY REPORTS ON FLOATER PROJECTS:**

100+ page monthly reports providing up-to-date details for current and planned floating production projects

- **2018/22 FORECAST OF ORDERS:**

An in-depth market analysis and five year forecast of orders for floating production systems

- **SEARCHABLE DATABASE**

Internet accessible database with daily updated info direct from industry sources on current and planned deepwater projects

**REQUEST YOUR SAMPLE REPORT AND A FREE FIVE DAY TRIAL:  
VISIT [WWW.WORLDENERGYREPORTS.COM](http://WWW.WORLDENERGYREPORTS.COM) OR CALL +1-212-477-6700**

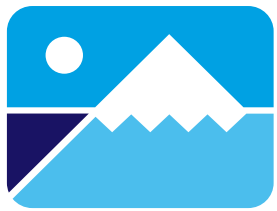

PacificGreen  
Marine

# A new generation of scrubbing technology

Simple patented design • No moving parts or media • Straight through or bypass designs



ENVI-Marine™

Pacific Green offers the simplest solution for the 2020 regulations

One decision, one supplier, one solution

Fully customised process from bespoke design through to installation and commissioning

Unrivalled manufacturing capacity and International Technical Service Centres

Our expert team is on hand to deliver a successful solution

Visit [www.pacificgreenmarine.com](http://www.pacificgreenmarine.com) or email our team at [enquiries@pacificgreenmarine.com](mailto:enquiries@pacificgreenmarine.com) for more information



PacificGreen  
Technologies Group